

Electrical Distribution

Low Voltage Final Distribution

Protection and Control

PowerTag and SmartLink	Page 56
Mini Pragma Enclosure	Page 57
Easy9 - MCB	Page 58
Easy9 RCCB , RCBO & SPD	Page 59
Acti 9 - iK60N & iC60N	Page 60
Acti 9 - iC60H & iC60L	Page 61
Acti 9 - C60H DC	Page 62
Acti 9 - C120N & C120H	Page 63
Acti 9 - Electrical Auxiliary & Vigi Module	Page 64
Acti 9 - RCCB & RCBO	Page 65
Acti 9 - Surge Arrester	Page 66
Acti 9 - Contactor iCT	Page 67
Acti 9 - Impulse relay iTL & Isolating Switch iSW	Page 68
Acti 9 - STI	Page 69

Low Voltage Power Distribution

EasyPact Range

Easypact EZC 100	Page 70
Easypact EZC 100 Accessories & Auxiliary	Page 71
Easypact EZC250F/N/H	Page 72
Easypact EZCV250 ELCB	Page 73
Easypact 250 Accessories & Auxiliaries	Page 74
EasyPact 400/630, EZC400/630 N/H	Page 75
Easypact CVS fixed B,F,N type	Page 76

Compact NSXm

Compact NSXm E/B fixed type	Page 77
Compact NSXm F/N fixed type	Page 78
Compact NSXm H fixed type & Auxiliaries	Page 79

Molded Case Circuit Breaker

Compact NSX fixed B/F type	Page 80
Compact NSX fixed N/H type	Page 81
Compact NSX plug-in/ drawout B/F/N/H type	Page 82
Compact NSX accessories	Page 83

Compact NS Range

Compact NS 630A to 3200A manually and electrical operation	Page 85
Compact NS drawout / withdrawable type	Page 86

Masterpact MTZ

Masterpact MTZ1 (630 to 1600A)	Page 88
Masterpact MTZ2 & MTZ3 (800 to 6300A)	Page 90
Masterpact MTZ Micrologic Trip Unit	Page 92
Auxiliaries of Masterpact MTZ1	Page 93
Auxiliaries of Masterpact MTZ2&3	Page 94

Electrical Distribution

Air Circuit Breaker

EasyPact MVS	Page 95
EasyPact MVS Accessories	Page 96
Masterpact NT & Accessories	Page 97
Masterpact NW	Page 98
Masterpact NW Accessories	Page 99
Micrologic control unit & Accessories	Page 100

Automatic Source Changeover System

ATNSX Power Source Changeover System	Page 101
ATS Compact NS and Compact NSX	Page 102
ATS Masterpact NT	Page 103
ATS Masterpact NW	Page 104

Load Break Switches

Interpact INS	Page 105
Temperature management	Page 106
Aluminium resistance heaters	Page 107

Medium Voltage

Secondary Distribution Switchgear

SM6	Page 109
-----	----------

Ring Main Units

RM6	Page 110
-----	----------

Metal Enclosed Motor Starters

Motorpact	Page 111
-----------	----------

Primary Distribution Switchgear

MCset	Page 112
-------	----------

Circuit Breakers

Evolis	Page 113
--------	----------

SF6	Page 115
-----	----------

MV Components

CPX - CLX - CBX - CVX	Page 116
-----------------------	----------

Contactors

Rollarc	Page 117
---------	----------

Fuses

Fusarc	Page 118
--------	----------

Fault Passage Indicators

Flair 219/279	Page 119
---------------	----------

Flair 2xD	Page 119
-----------	----------

Transformers

Trihal SCB10	Page 120
--------------	----------

Electrical Distribution

Protection Relays

Sepam Series 10	Page 122
Sepam Series 20	Page 123
Sepam Series 40	Page 124
Sepam Series 60	Page 125
Sepam Series 80	Page 127
Accessories Sepam Series 10, 20, 40, 60, 80	Page 129
Micom Series 10, 20, 30, 40	Page 130
VAMP	Page 137

Power Supply

Easergy PS100	Page 139
---------------	----------

Busway

The Prisma iPM solution	Page 141
-------------------------	----------

Power Factor Correction

Capacitor	Page 148
Capacitor Controller	
Detune Reactor	

Power Meter

PM2000	Page 150
PM5000	Page 152
PM8000	Page 154
ION7550	Page 156
iEM3200	Page 158
Current Transformer	Page 160

Introducing the Acti 9 communication system

Acti 9 Smartlink: The heart of the system



Available only from
Schneider Electric

Modbus processing interface providing:

- Circuit breaker status
- Energy meter output
- Contactor/impulse relay control and status

Smart functions integrated:

- Energy counting from pulses
- Average power calculation
- Event counting
- Running hours

Circuit breaker auxiliary



- 24V DC low-level contacts
 - CB open/closed position
 - CB tripping indication

iOF+SD24, OF+SD24

Pre-cabled links



- Pre-cabled for error-proof connections
- Available in various lengths

Energy meters



- DIN rail mounted
- Designed for metering active energy consumed by a single- or 3-phase electric circuit

iEM2000T iEM3110

Contactor auxiliary



- 24V:
 - Command to contactor
 - Open/closed contactor position
- 230V command to contactor
 - Various configurable local/remote control combinations

iACT 24

Integrated control circuit breaker



- 24VDC and 230 VAC
 - Command
 - Open/close position
 - Tripping indication
- Various configurable local and remote control combinations

Reflex™ iC60

Impulse relay auxiliary



- 24V:
 - Command to impulse relay
 - Open/closed impulse relay position
- 230V command to impulse relay
 - Various configurable local/remote control combinations

iATL 24

Circuit breaker remote control



- Remote opening/closing of MCBs
- Remote control resetting after tripping
- 24VDC and 230VAC command and MCB position
- Various configurable local/remote control combinations

RCA iC60

Acti9: The efficiency you deserve

Acti 9 communication system

- > **Smart**
 - Centralize control, collect energy meter data with just a simple, ready-to-connect communication module.
 - Large diversity of data available to universal Modbus protocol.
- > **Efficient**
 - One-click, prefabricated wiring for comprehensive communication between your distribution panel and any facility management system.
- > **Safe**
 - Reliable, error-proof manufacturer guaranteed connections
 - EMC tested for immunity, radiated, and conducted safety.

Acti 9 Smartlink: the heart of the system

Available only from Schneider Electric™

11 input/output channels

24V DC power supply

Modbus address encoders

Modbus RS-485 connection

Protection monitoring

Load control switching

Energy metering

Ready to connect to any facility management solution

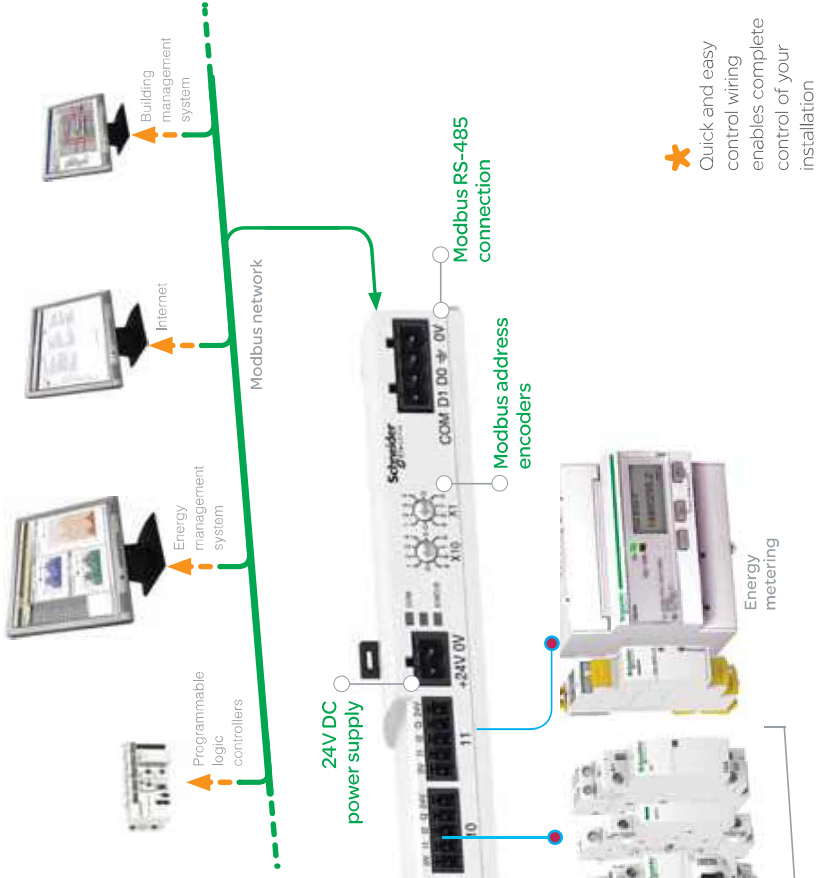

Quick and easy control wiring enables complete control of your installation



Meets the challenge of all your applications
Interior and exterior lighting, load monitoring, and cost allocation



Monitor and adjust specific loads
Detailed load control, reduced downtime, and accurately planned maintenance



PowerTag and SmartLink

PowerTag is a wireless-communication energy sensor and is designed for Energy Management, Load Monitoring and Power Availability applications.

Measurements real-time values:

- Phase-to-neutral and phase-to-phase Voltage
- Current per phase
- Active / Reactive* Power, total and per phase
- Power factor*
- Frequency*

Accurate Class 1 in accordance with the IEC 61557-12

Voltage loss alarms:

PowerTag energy sensor sends a "voltage loss" alarm and the current-per-phase value before being de-energized.

Easy installation & Commissioning:

- Perfect for retrofit as it has no impact on DIN rail as it fits directly on the protective device
- PowerTag are detected automatically by the concentrator during commissioning

PowerTag là cảm biến năng lượng truyền thông không dây, được thiết kế cho các ứng dụng quản lý năng lượng, giám sát và cung cấp điện năng.

Đo lường các giá trị theo thời gian thực:

- Điện áp pha, điện áp dây
- Dòng điện
- Công suất hiệu dụng, công suất phản kháng
- Hệ số công suất
- Tần số

Độ chính xác Class 1 theo tiêu chuẩn IEC 61557-12

Cảnh báo mất điện áp:

PowerTag sẽ gửi tín hiệu "mất điện áp" và các giá trị hiện hành trước khi mất nguồn.

Dễ dàng lắp đặt và vận hành:

- Gắn trực tiếp lên cầu dao bảo vệ, hoàn hảo cho việc nâng cấp tủ điện hiện hành.
- Smartlink tự động phát hiện các PowerTag trong khi vận hành.



Unit price (incl.VAT) in VND

PowerTag (For 18mm width module Circuit Breaker)

Type	Mounting	Description	Reference	Unit Price
1P+wire	Top or bottom	PowerTag A9 M63 1PW	A9MEM1520	3,517,800
1P+N	Top	PowerTag A9 M63 1PN T	A9MEM1521	3,517,800
	Bottom	PowerTag A9 M63 1PN B	A9MEM1522	3,517,800
3P	Top or bottom	PowerTag A9 M63 3P	A9MEM1540	5,528,600
3P+N	Top	PowerTag A9 M63 3PN T	A9MEM1541	5,528,600
	Bottom	PowerTag A9 M63 3PN B	A9MEM1542	5,528,600

SmartLink For Commercial & Building Applications

Type	Description	Reference	Unit Price
Monitoring	Acti9 Smartlink SI D 20	A9XMWA20	8,988,100
Monitoring	Acti9 Smartlink SI D 100	A9XMWA100	13,482,700

Technoplastic Enclosure

Degree of protection: IP 40, IK07

Rated current

4 module: 50A

6 to 36 module: 63A

Material

Self-extinguishing technoplastic

Resistant to fire and abnormal heat 650°C

Insulation: Class 2

Complies with standard IEC 60695-2-11

IEC 60439-3, IEC 60529, EN 50102, IEC 60670-24

Easy9 Box

Tủ điện

Cấp độ bảo vệ: IP 40, IK07

Dòng điện định mức

4 module: 50A

6 đến 36 module: 63A

Vật liệu

Vật liệu tổng hợp chống cháy

Chống cháy và chịu nhiệt độ cao đến 650°C

Độ cách ly điện: Cấp 2

Đáp ứng tiêu chuẩn IEC 60695-2-11

IEC 60439-3, IEC 60529, EN 50102, IEC 60670-24

Tủ điện Easy9

Unit price (incl.VAT) in VND



Flush mounted technoplastic enclosure - Tủ điện nhựa âm tường - Mini pragma

No of module (18mm)	Reference		Dimensions (mm) (WxHxD)	Unit Price
	White door	Smoked door		
4	MIP22104	MIP22104T	150x252x98	397,100
6	MIP22106	MIP22106T	186x252x98	440,000
8	MIP22108	MIP22108T	222x252x98	518,100
12	MIP22112	MIP22112T	294x252x98	734,800
18	MIP22118	MIP22118T	402x252x98	1,125,300
24	MIP22212	MIP22212T	294x377x98	1,237,500
36	MIP22312	MIP22312T	294x502x98	1,449,800



Wall mounted technoplastic enclosure - Tủ điện nhựa nổi - Mini pragma

No of module (18mm)	Reference		Dimensions (mm) (WxHxD)	Unit Price
	White door	Smoked door		
4	MIP12104	MIP12104T	124x198x95	388,300
6	MIP12106	MIP12106T	160x198x95	425,700
8	MIP12108	MIP12108T	196x228x101.5	508,200
12	MIP12112	MIP12112T	268x228x101.5	686,400
18	MIP12118	MIP12118T	376x228x101.5	1,124,200
24	MIP12212	MIP12212T	268x353x102	1,266,100
36	MIP12312	MIP12312T	267x478x102	1,485,000



Metal Enclosure Acti9

No of module (18mm)	Reference	Dimensions (mm) (WxHxD)		Unit Price
4	A9HESN04	221x244x98		885,500
6	A9HESN06	257x244x98		1,040,600
8	A9HESN08	293x244x98		1,249,600
12	A9HESN12	365x244x98		1,457,500
16	A9HESN16	437x244x98		2,186,800



Flush mounted technoplastic enclosure - Tủ điện nhựa âm tường - Easy9 Box

No of module (18mm)	Reference	Dimensions (mm) (WxHxD)		Unit Price
4	EZ9E0104	136x 222 x 92		178,200
8	EZ9E0108	208 x 222 x 92		315,700
12	EZ9E0112	280 x 222 x 92		433,400

* Enclosure not include circuit breaker

1P, 2P, 3P, 4P MCBs for control & protection of circuits against overloads and short-circuits
Residential network applications
Compliance with IEC 898
C Curve

MCB 1P, 2P, 3P, 4P dùng để kiểm soát, bảo vệ quá tải và ngắn mạch.
Dùng trong mạng lưới dân dụng.
Tiêu chuẩn IEC 898
Đường cong loại C

Unit price (incl.VAT) in VND

Easy9 MCB - 1P, 2P , 3P, 4P 4.5kA

Easy9 MCB - 1P & 2P , 4.5kA, 230V		1P	2P
Rating	Reference	Unit Price	Reference
6	EZ9F34106	82,500	EZ9F34206
10	EZ9F34110	82,500	EZ9F34210
16	EZ9F34116	82,500	EZ9F34216
20	EZ9F34120	82,500	EZ9F34220
25	EZ9F34125	82,500	EZ9F34225
32	EZ9F34132	82,500	EZ9F34232
40	EZ9F34140	121,000	EZ9F34240
50	EZ9F34150	196,900	EZ9F34250
63	EZ9F34163	196,900	EZ9F34263
Easy9 MCB - 3P & 4P , 4.5kA, 400V		3P	4P
Rating	Reference	Unit Price	Reference
6	EZ9F34306	413,600	
10	EZ9F34310	413,600	
16	EZ9F34316	413,600	
20	EZ9F34320	413,600	
25	EZ9F34325	413,600	
32	EZ9F34332	413,600	
40	EZ9F34340	413,600	EZ9F34440
50	EZ9F34350	632,500	EZ9F34450
63	EZ9F34363	632,500	EZ9F34463



EZ9 MCB 1P



EZ9 MCB 2P



EZ9 MCB 3P



EZ9 MCB 4P

Cầu dao tự động Easy9 bao gồm các chức năng:



Bảo vệ chống dòng quá tải
Bảo vệ chống dòng ngắn mạch

Tuân theo tiêu chuẩn IEC 60898 - 1

Khả năng ngắt ngắn mạch (Icn)

Ph/N	230VAC	4500A
Ph/Ph	400VAC	4500A

Số lần đóng ngắt (O-C)

Bằng điện	4,000 lần
Bằng cơ khí	10,000 lần

Residual Current Circuit breaker (RCCB)

Comply with IEC 61008-1
Isolation, Switching, Leakage Current

RCBO- Residual Current Circuit Breaker with Overcurrent Protection

Against overcurrent and insulation fault
Comply with IEC 61009-1

Surge Arrester (SPD)

Provide overvoltage protection
for housing purpose (TV, refrigerators, computers, ..)

Cầu dao chống dòng rò (RCCB)

Phù hợp với tiêu chuẩn IEC 61008-1
Cách ly, đóng cắt, chống dòng rò

Cầu dao bảo vệ được tích hợp chống dòng rò (RCBO)

Bảo vệ quá tải và chống dòng rò.
Phù hợp với tiêu chuẩn IEC 61009-1

Thiết bị chống sét lan truyền (SPD)

Bộ chống sét bảo vệ quá điện áp cho các thiết bị dân dụng
(tivi, tủ lạnh, máy vi tính...), viễn thông và điện tử công nghiệp



RCCB 2P EZ9



RCCB 4P EZ9



RCBO 1P+N EZ9



SPD 1P EZ9

Unit price (incl.VAT) in VND

Easy9 RCCB [AC type]

Easy9 RCCB, 2P, 230V

Rating (A)	Sensitivity (mA)	Reference	Unit Price
25	30	EZ9R36225	760,100
40	30	EZ9R36240	798,600
63	30	EZ9R36263	837,100

Easy9 RCCB, 4P, 400V

Rating (A)	Sensitivity (mA)	Reference	Unit Price
25	30	EZ9R34425	1,085,700
40	30	EZ9R34440	1,162,700
63	30	EZ9R34463	1,551,000
40	300	EZ9R64440	1,125,300
63	300	EZ9R64463	1,279,300

Note: RCCB need to be associated with a MCB for cable protection
RCCB cần lắp kèm với một MCB để bảo vệ ngăn mạch và quá tải

Easy9 RCBO [AC type]

Easy9 RCBO 4.5kA 1P+N

Rating (A)	Sensitivity (mA)	Reference	Unit Price
10	30	EZ9D34610	641,300
16	30	EZ9D34616	641,300
20	30	EZ9D34620	641,300
25	30	EZ9D34625	740,300
32	30	EZ9D34632	740,300
40	30	EZ9D34640	740,300

Easy9 SPD

Easy9 SPD 20kA & 45kA, 1P /1P+N /3P+N, type 2

Số cực	I _{max}	Reference	Unit Price
1P	20kA	EZ9L33120	631,400
1P	45kA	EZ9L33145	669,900
1P+N	20kA	EZ9L33620	829,400
3P+N	20kA	EZ9L33720	1,422,300
3P+N	45kA	EZ9L33745	1,476,200

RCCB

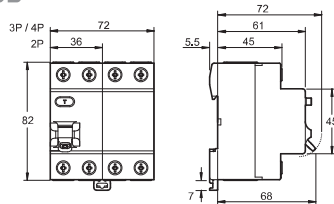

RCBO

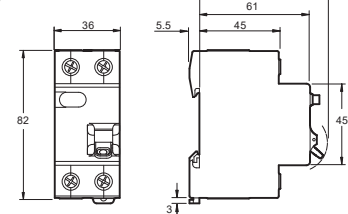

SPD

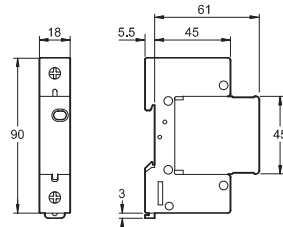

1P, 2P, 3P, 4P MCBs for control & protection of circuits against overloads and short-circuits

Industrial or public network applications

Compliance with IEC 898 (iK60N)

Compliance with both IEC 898, IEC 947-2 (iC60)

Impulse withstand voltage (Uimp) : 4kV (iK60N), 6kV (iC60)

C Curve (B,D curves please consult us)

MCB 1P, 2P, 3P, 4P dùng để kiểm soát, bảo vệ quá tải và ngắn mạch. Dùng trong mạng lưới dân dụng và công nghiệp.

Tiêu chuẩn IEC 898 (iK60N)

Tiêu chuẩn IEC 898, IEC 947-2 (iC60)

Điện áp thử nghiệm xung (Uimp) : 4kV (iK60N) , 6kV (iC60)

Đường cong loại C (đường cong B,D vui lòng liên hệ chúng tôi)

Unit price (incl.VAT) in VND

Acti 9 iK60N - 1P, 2P , 3P & 4P, 6kA

iK60N - 1P & 2P , 6kA, 230V

Rating	Reference	1P	Unit Price	Reference	2P	Unit Price
6	A9K27106		156,200	A9K27206		437,800
10	A9K27110		156,200	A9K27210		437,800
16	A9K27116		156,200	A9K27216		437,800
20	A9K27120		156,200	A9K27220		437,800
25	A9K27125		156,200	A9K27225		437,800
32	A9K27132		156,200	A9K27232		437,800
40	A9K24140		193,600	A9K24240		526,900
50	A9K24150		237,600	A9K24250		728,200
63	A9K24163		237,600	A9K24263		728,200

iK60N - 3P & 4P, 6kA, 400V

Rating	Reference	3P	Unit Price	Reference	4P	Unit Price
6	A9K24306		708,400	A9K24406		1,106,600
10	A9K24310		708,400	A9K24410		1,106,600
16	A9K24316		708,400	A9K24416		1,106,600
20	A9K24320		708,400	A9K24420		1,106,600
25	A9K24325		708,400	A9K24425		1,106,600
32	A9K24332		708,400	A9K24432		1,106,600
40	A9K24340		823,900	A9K24440		1,520,200
50	A9K24350		1,027,400	A9K24450		1,520,200
63	A9K24363		1,027,400	A9K24463		1,520,200

Acti 9 iC60N - 1P, 2P, 3P & 4P, 6kA

iC60N - 1P & 2P, 6kA, 230V

Rating	Reference	1P	Unit Price	Reference	2P	Unit Price
6	A9F74106		182,600	A9F74206		507,100
10	A9F74110		182,600	A9F74210		507,100
16	A9F74116		182,600	A9F74216		507,100
20	A9F74120		182,600	A9F74220		524,700
25	A9F74125		182,600	A9F74225		545,600
32	A9F74132		194,700	A9F74232		575,300
40	A9F74140		222,200	A9F74240		655,600
50	A9F74150		319,000	A9F74250		924,000
63	A9F74163		319,000	A9F74263		942,700

iC60N - 3P & 4P, 6kA, 400V

Rating	Reference	3P	Unit Price	Reference	4P	Unit Price
6	A9F74306		779,900	A9F74406		1,138,500
10	A9F74310		779,900	A9F74410		1,138,500
16	A9F74316		779,900	A9F74416		1,138,500
20	A9F74320		779,900	A9F74420		1,195,700
25	A9F74325		779,900	A9F74425		1,252,900
32	A9F74332		822,800	A9F74432		1,322,200
40	A9F74340		936,100	A9F74440		1,575,200
50	A9F74350		1,329,900	A9F74450		2,055,900
63	A9F74363		1,329,900	A9F74463		2,055,900



iK60N-1P



iK60N-2P



iC60N-3P



iC60N-4P

1P, 2P, 3P, 4P MCBs for control and protection of circuits against overloads and short-circuits
 Industrial or public network applications
 Compliance with IEC 898, IEC 947-2
 Impulse withstand voltage (Uimp): 6kV
 C Curve (B,D curves please consult us)

MCB 1P, 2P, 3P, 4P dùng để kiểm soát, bảo vệ quá tải và ngắn mạch.
 Dùng trong mạng lưới dân dụng hoặc công nghiệp
 Tiêu chuẩn IEC 898, IEC 947-2
 Điện áp thử nghiệm xung (Uimp) : 6kV
 Đường cong loại C (đường cong B,D vui lòng liên hệ chúng tôi)

Standard	IEC 947-2				IEC 898	
	1P 2,3,4P	100 to 133V 220 to 240V	220 to 240V 380 to 415V	- 440V	230V 400V	
MCB	iC60H	iC60L	iC60H	iC60L	iC60H	iC60L
Rating	0,5 to 4A	70kA 100kA	70kA 100kA	50kA 70kA	10kA 15kA	10kA 15kA
	6 to 25A	30kA -	15kA 25kA	10kA 20kA	10kA 15kA	10kA 15kA
	32/40A	30kA -	15kA 20kA	10kA 15kA	10kA 15kA	10kA 15kA
	50/63A	- -	15kA 15kA	10kA 10kA	10kA -	10kA -

Unit price (incl.VAT) in VND

Acti9 iC60H - 1P, 2P, 3P & 4P

iC60H - 1P& 2P



iC60H-1P

Rating	Reference	1P	Unit Price	Reference	2P	Unit Price
6	A9F84106		315,700	A9F84206		1,145,100
10	A9F84110		315,700	A9F84210		1,145,100
16	A9F84116		315,700	A9F84216		1,145,100
20	A9F84120		331,100	A9F84220		1,145,100
25	A9F84125		350,900	A9F84225		1,236,400
32	A9F84132		369,600	A9F84232		1,301,300
40	A9F84140		420,200	A9F84240		1,482,800
50	A9F84150		525,800	A9F84250		1,854,600
63	A9F84163		616,000	A9F84263		1,992,100

iC60H - 3P& 4P



iC60H-2P

Rating	Reference	3P	Unit Price	Reference	4P	Unit Price
6	A9F84306		1,720,400	A9F84406		2,472,800
10	A9F84310		1,720,400	A9F84410		2,472,800
16	A9F84316		1,720,400	A9F84416		2,472,800
20	A9F84320		1,806,200	A9F84420		2,598,200
25	A9F84325		1,892,000	A9F84425		2,720,300
32	A9F84332		1,996,500	A9F84432		2,869,900
40	A9F84340		2,227,500	A9F84440		3,265,900
50	A9F84350		2,783,000	A9F84450		3,825,800
63	A9F84363		3,052,500	A9F84463		4,111,800

Acti9 iC60L - 1P, 2P, 3P & 4P

iC60L - 1P& 2P



iC60L-3P

Rating	Reference	1P	Unit Price	Reference	2P	Unit Price
6	A9F94106		499,400	A9F94206		1,348,600
10	A9F94110		499,400	A9F94210		1,348,600
16	A9F94116		499,400	A9F94216		1,348,600
20	A9F94120		523,600	A9F94220		1,375,000
25	A9F94125		550,000	A9F94225		1,441,000
32	A9F94132		584,100	A9F94232		1,486,100
40	A9F94140		664,400	A9F94240		1,679,700
50	A9F94150		833,800	A9F94250		1,919,500
63	A9F94163		953,700	A9F94263		2,074,600

iC60L - 3P& 4P



iC60L-4P

Rating	Reference	3P	Unit Price	Reference	4P	Unit Price
6	A9F94306		1,798,500	A9F94406		2,698,300
10	A9F94310		1,798,500	A9F94410		2,698,300
16	A9F94316		1,798,500	A9F94416		2,698,300
20	A9F94320		1,887,600	A9F94420		2,750,000
25	A9F94325		1,976,700	A9F94425		2,800,600
32	A9F94332		2,084,500	A9F94432		2,952,400
40	A9F94340		2,373,800	A9F94440		3,339,600
50	A9F94350		2,966,700	A9F94450		4,021,600
63	A9F94363		3,246,100	A9F94463		4,225,100

Miniature Circuit Breaker

Acti 9 - C60H DC

1P, 2P MCBs for control and protection of DC network against overloads and short-circuits, control and isolation
Industrial control and automations, transport, renewable energy... applications
Compliance with IEC 60947-2
C Curve
Operating voltage :
1P: 24...250 VDC
2P: 24...500 VDC

MCB 1P, 2P dùng để kiểm soát, bảo vệ quá tải, ngắn mạch và cách ly mạng điện một chiều.
Dùng trong mạng lưới công nghiệp, vận tải và năng lượng.
Tiêu chuẩn IEC 60947-2.
Đường cong loại C
Điện áp hoạt động:
1P: 24...250 VDC
2P: 24...500 VDC

C60H DC breaking capacity

Standard	Type	Voltage (VDC)	Icu(kA)
As IEC947-2	1P	110	20
	1P	220	10
	1P	250	6
	2P	220	20
	2P	440	10
	2P	500	6

Unit price (incl.VAT) in VND

Acti 9 - C60H-DC, 1P



C60H-DC 1P

Rating, In (A)	Reference	Unit Price
0.5	A9N61500	1,106,600
1	A9N61501	922,900
2	A9N61502	922,900
3	A9N61503	922,900
4	A9N61504	922,900
5	A9N61505	922,900
6	A9N61506	922,900
10	A9N61508	735,900
13	A9N61509	735,900
15	A9N61510	735,900
16	A9N61511	735,900
20	A9N61512	735,900
25	A9N61513	773,300
30	A9N61514	773,300
32	A9N61515	773,300
40	A9N61517	773,300
50	A9N61518	928,400
63	A9N61519	1,114,300

Acti 9 - C60H-DC, 2P



C60H-DC 2P

Rating, In (A)	Reference	Unit Price
0.5	A9N61520	2,214,300
1	A9N61521	1,801,800
2	A9N61522	1,801,800
3	A9N61523	1,801,800
4	A9N61524	1,720,400
5	A9N61525	1,720,400
6	A9N61526	1,567,500
10	A9N61528	1,567,500
13	A9N61529	1,567,500
15	A9N61530	1,567,500
16	A9N61531	1,655,500
20	A9N61532	1,655,500
25	A9N61533	1,701,700
30	A9N61534	1,701,700
32	A9N61535	1,701,700
40	A9N61537	1,731,400
50	A9N61538	2,041,600
63	A9N61539	2,450,800

1P, 2P, 3P, 4P poles MCBs for control and protection of circuits against overloads and short-circuits
 Industrial or public network applications
 Compliance with IEC 898, IEC 947-2
 C Curve (B,D curves please consult us)
 Impulse withstand voltage (Uimp) : 6kV

MCB 1P, 2P, 3P, 4P dùng để kiểm soát, bảo vệ quá tải và ngắn mạch.
 Dùng trong mạng lưới dân dụng hoặc công nghiệp
 Tiêu chuẩn IEC 898, IEC 947-2
 Đường cong loại C (đường cong loại B, D vui lòng liên hệ chúng tôi)
 Điện áp thử nghiệm xung (Uimp) : 6kV

Standard	Type	Voltage (VAC)	C120N Icu(kA)	C120H Icu(kA)
As IEC898	1P	230/240	10	15
	2,3,4P	400/415	10	15
As IEC947-2	1P	220/240	10	15
	2,3,4P	220/240	20	30
		380/415	10	15

Unit price (incl.VAT) in VND

Acti 9 C120N - 1P, 2P, 3P & 4P

C120N - 1P & 2P

Rating	Reference	1P Unit Price	Reference	2P Unit Price
63	A9N18356	1,040,600	A9N18360	2,202,200
80	A9N18357	1,118,700	A9N18361	2,286,900
100	A9N18358	1,202,300	A9N18362	2,465,100
125	A9N18359	1,285,900	A9N18363	2,646,600

C120N - 3P & 4P

Rating	Reference	3P Unit Price	Reference	4P Unit Price
63	A9N18364	3,426,500	A9N18371	4,402,200
80	A9N18365	3,536,500	A9N18372	4,449,500
100	A9N18367	3,714,700	A9N18374	4,581,500
125	A9N18369	3,777,400	A9N18376	4,869,700

Acti 9 C120H - 1P, 2P, 3P & 4P

C120H - 1P & 2P

Rating	Reference	1P Unit Price	Reference	2P Unit Price
63	A9N18445	1,074,700	A9N18456	2,269,300
80	A9N18446	1,152,800	A9N18457	2,352,900
100	A9N18447	1,238,600	A9N18458	2,538,800
125	A9N18448	1,323,300	A9N18459	2,725,800

C120H - 3P & 4P

Rating	Reference	3P Unit Price	Reference	4P Unit Price
63	A9N18467	3,528,800	A9N18478	4,534,200
80	A9N18468	3,642,100	A9N18479	4,583,700
100	A9N18469	3,826,900	A9N18480	4,720,100
125	A9N18470	3,888,500	A9N18481	5,016,000



C120N-1P



C120N-2P



C120H-3P



C120H-4P

Dimensions (mm)

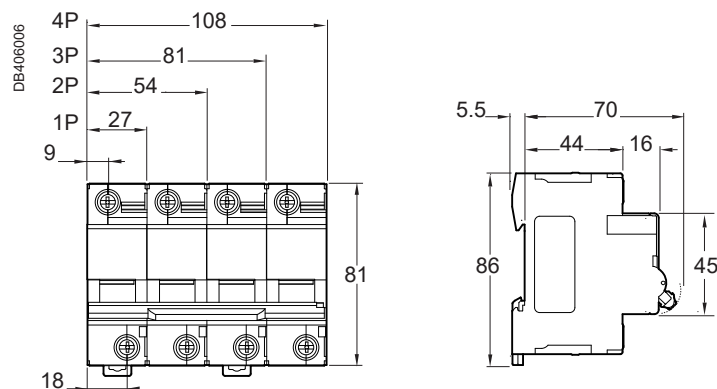

Electrical auxiliaries for iC60, iC60H-DC, iC120
 Vigi modules for iC60, iC120 circuit breakers
 30 and 300mA, class AC~
 Comply with IEC1009

Phụ kiện dùng cho cầu dao tự động iC60, C60H-DC, C120
 Module vigi chống dòng rò dùng cho CB iC60, iC120
 30 & 300mA, class AC~
 Tiêu chuẩn IEC1009

Unit price (incl.VAT) in VND

Electrical auxiliaries for iC60



iOF



iMN



iOF+iSD



Vigi Module 3P

Type	Control Voltage (VAC)	Control Voltage (VDC)	Reference	Unit Price
Shunt release				
iMX+iOF	100..415	110..130	A9A26946	1,632,400
	48	48	A9A26947	1,568,600
	12..24	12..24	A9A26948	1,568,600
Undervoltage release				
iMN instantaneous	220..240		A9A26960	1,925,000
	48	48	A9A26961	1,426,700
iMNs delayed [s]	220..240		A9A26963	1,754,500
Auxiliary contacts				
iOF	240..415	24..130	A9A26924	409,200
iOF+iSD/iOF	240..415	24..130	A9A26929	434,500
Fault indicating switch				
iSD			A9A26927	409,200
RCA remote control				
iC60 1-2P	230		A9C70112	10,632,600
iC60 3-4P	230		A9C70114	10,632,600
ARA automatic reclosers				
iC60 1-2P	230		A9C70132	14,752,100
iC60 3-4P	230		A9C70134	14,752,100

Electrical auxiliaries for Acti 9 C60H-DC, C120

Type	Control Voltage (VAC)	Control Voltage (VDC)	Reference	Unit Price
Shunt release				
iMX+iOF	100..415	110..130	A9N26946	1,600,500
	48	48	A9N26947	1,537,800
	12..24	12..24	A9N26948	1,537,800
Undervoltage release				
iMN instantaneous	220..240	-	A9N26960	1,888,700
	48	48	A9N26961	1,399,200
Auxiliary contacts				
iOF	24..415	24..130	A9N26924	400,400
iOF+iSD/iOF	24..415	24..130	A9N26929	427,900
Fault indicating switch				
iSD	24..415	24..130	A9N26927	400,400

Vigi module for iC60 [AC type]

No of Poles	Voltage (VAC)	Rating (A)	Sensitivity (mA)	Reference	Unit Price	
2P	220/415	≤ 25A	30	A9V41225	2,965,600	
			300	A9V44225	2,074,600	
			≤ 63A	30	A9V41263	4,445,100
		≤ 63A	300	A9V44263	3,111,900	
			300[s]	A9V25263	4,357,100	
			30	A9V41325	4,000,700	
3P	220/415	≤ 25A	300	A9V44325	2,799,500	
			≤ 63A	30	A9V41363	6,001,600
			300	A9V44363	4,199,800	
		≤ 63A	300[s]	A9V25363	5,880,600	
			30	A9V41425	4,592,500	
			300	A9V44425	3,215,300	
4P	220/415	≤ 63A	30	A9V41463	6,889,300	
			300[s]	A9V25463	6,751,800	
			300			

Residual Current Circuit breaker (RCCB)
 Comply with IEC 1008
 Isolation, Switching, Leakage Current
 RCBO- Residual Current Circuit Breaker with Overcurrent Protection
 Against overcurrent and insulation fault
 Comply with IEC 898 and IEC 1009

Cầu dao chống dòng rò (RCCB)
 Phù hợp với tiêu chuẩn IEC 1008
 Cách ly, đóng cắt, chống dòng rò
 Cầu dao bảo vệ được tích hợp chống dòng rò (RCBO)
 Bảo vệ quá tải và chống dòng rò.
 Phù hợp với tiêu chuẩn IEC 898 và IEC 1009

Unit price (incl.VAT) in VND



iIDK-2P



iID-2P



iID-4P



iDPN N 1P+N

Acti9 iIDK RCCB [AC type]

Acti 9 iIDK, 2P, 240V

Rating (A)	Sensitivity(mA)	Reference	Unit Price
25	30	A9R50225	1,212,200
40		A9R50240	1,278,200
25	300	A9R75225	1,335,400
40		A9R75240	1,456,400

Acti 9 iIDK, 4P, 415V

Rating (A)	Sensitivity(mA)	Reference	Unit Price
25	30	A9R50425	1,941,500
40		A9R50440	2,043,800
63		A9R70463	3,476,000
25	300	A9R75425	1,903,000
40		A9R75440	2,002,000
63		A9R75463	2,433,200

Acti 9 iID RCCB [AC type]

Acti 9 iID RCCB, 2P, 240V

Rating (A)	Sensitivity(mA)	Reference	Unit Price
25	30	A9R71225	1,447,600
40		A9R71240	1,523,500
63		A9R71263	2,601,500
100		A9R11291	4,283,400
40	100	A9R12240	1,586,200
63		A9R12263	2,081,200
100		A9R12291	3,426,500
25	300	A9R74225	1,599,400
40		A9R74240	1,745,700
63		A9R74263	1,820,500
100		A9R14291	2,999,700

Acti 9 iID RCCB, 4P, 415V

Rating (A)	Sensitivity(mA)	Reference	Unit Price
40	30	A9R71440	2,448,600
63		A9R71463	4,160,200
40	100	A9R12440	2,175,800
63		A9R12463	3,328,600
40	300	A9R74440	2,398,000
63		A9R74463	2,912,800
100		A9R14491	4,798,200
100	300[S]	A9R15491	6,716,600

Note: RCCB need to be associated with a MCB for cable protection
 RCCB cần lắp kèm với một MCB để bảo vệ ngăn mạch và quá tải

Acti 9 RCBO iDPN N 1P+N, 6kA [AC type]

Rating (A)	Sensitivity(mA)	Reference	Unit Price
6	30	A9D31606	1,998,700
10		A9D31610	1,998,700
16		A9D31616	1,998,700
20		A9D31620	1,998,700
25		A9D31625	2,174,700
32		A9D31632	2,174,700
40		A9D31640	2,174,700
6	300	A9D41606	2,054,800
10		A9D41610	2,054,800
16		A9D41616	2,054,800
20		A9D41620	2,236,300
25		A9D41625	2,236,300
32		A9D41632	2,236,300
40		A9D41640	2,236,300

iPRF1, iPRD, iPF K surge arrester provide overvoltage protection for housing purpose (TV, refrigerators, computers, ...), telecommunication and industrial electronics (automation systems, motor control, ...)

The iPRF1, iPRD, iPF K surge arrester uses an MOV (metal oxide varistor) to eliminate atmospheric and industrial voltage surges.

Type 1 surge arresters against direct lightning strokes according to standards IEC 61643-1 and EN 61643-11

Type 2 surge arresters against indirect lightning strokes according to standards IEC 61643-1 and EN 61643-1

Bộ chống sét iPRF1, iPRD, iPF K bảo vệ quá điện áp cho các thiết bị dân dụng (tivi, tủ lạnh, máy vi tính...), viễn thông và điện tử công nghiệp (hệ thống tự động, bộ điều khiển tốc độ...)

Bộ chống sét iPRF1, iPRD, iPF K sử dụng MOV (metal oxide varistor) loại trừ các xung quá điện áp

Chống sét loại 1 dùng trong chống sét trực tiếp theo tiêu chuẩn IEC 61643-1 and EN 61643-11

Chống sét loại 2 dùng trong chống sét gián tiếp theo tiêu chuẩn IEC 61643-1 and EN 61643-11

Unit price (incl.VAT) in VND

Acti 9 Surge Arrester - iPRF1, type 1 + 2

Pole	Iimp (kA) (10/350µs)	I _{max} (kA) (8/20µs)	Reference	Unit Price
1P+N	12.5/50 N/PE	50	A9L16632	12,347,500
3P	12.5	50	A9L16633	18,291,900
3P+N	12.5/50 N/PE	50	A9L16634	22,865,700

Acti 9 Surge Arrester - iPRD, type 2, 1P, 1P+N, 3P+N, drawout

iPRD type 2, 1P/1P+N, 230V, Draw-out

Pole	I _{max} (8/20µs)	Reference	Unit Price
1P	8kA	A9L08100	1,843,600
1P	20kA	A9L20100	1,976,700
1P	40kA	A9L40100	2,107,600
1P	65kA	A9L65101	2,596,000
1P+N	8kA	A9L08500	2,766,500
1P+N	20kA	A9L20500	3,294,500
1P+N	40kA	A9L40500	3,491,400
1P+N	65kA	A9L65501 (*)	4,568,300

iPRD type 2, 3P+N, 400V, Draw-out

Pole	I _{max} (8/20µs)	Reference	Unit Price
3P+N	20kA	A9L20600	6,586,800
3P+N	40kA	A9L40600	7,574,600
3P+N	65kA	A9L65601 (*)	9,157,500

Acti 9 Surge Arrester - iPF K, type 2, 1P, 1P+N & 3P+N, Fixed

iPF K type 2, 1P, 230V, Fixed

Pole	I _{max} (8/20µs)	Reference	Unit Price
1P	20kA	A9L15691	1,813,900
1P	40kA	A9L15686	1,934,900

iPF K type 2, 1P+N, 230V, Fixed

Pole	I _{max} (8/20µs)	Reference	Unit Price
1P+N	20kA	A9L15692	3,021,700
1P+N	40kA	A9L15687	3,203,200

iPF K type 2, 3P+N, 400V, Fixed

Pole	I _{max} (8/20µs)	Reference	Unit Price
3P+N	20kA	A9L15693	6,043,400
3P+N	40kA	A9L15688	7,252,300
3P+N	65kA	A9L15586	7,262,200

(*) The surge arrester with indication contact remove



iPRF1 - 1P+N



iPRD - 1P



iPF K - 1P+N

Modular CT contactors are used to control single-phase, three-phase and four-phase circuits (up to 100A)
 Current rating: 16 to 100A (category AC7a)
 Coil voltage 24, 230/240 VAC

Công tắc tơ dạng module CT dùng để điều khiển các mạng điện 1,2,3 và 4 dây (dòng điện đến 100A)
 Dòng điện định mức: 16 đến 100A (chế độ AC7a)
 Điện áp cuộn dây: 24, 230/240 VAC



iCT 25A 1NO



iCT 25A 3NO



iCT 4P 63A

Unit price (incl.VAT) in VND

Contactor iCT, 1P, coil voltage 230/240VAC

Type	Current	Width in mod. of 9mm	Reference	Unit Price
1NO	25A	2	A9C20731	766,700

Contactor iCT, 2P, coil voltage 24VAC

Type	Current (A)	Width in mod. of 9mm	Reference	Unit Price
2NO	25	2	A9C20132	1,007,600
2NO	63	4	A9C20162	2,418,900

Contactor iCT, 2P, coil voltage 230/240VAC

Type	Current (A)	Width in mod. of 9mm	Reference	Unit Price
1NO+1NC	16	2	A9C22715	893,200
2NO	16	2	A9C22712	850,300
2NO	25	2	A9C20732	1,168,200
2NC	25	2	A9C20736	964,700
2NO	40	4	A9C20842	1,402,500
2NO	63	4	A9C20862	2,103,200
2NO	100	6	A9C20882	5,698,000

Contactor iCT, 3P, coil voltage 230/240VAC

Type	Current (A)	Width in mod. of 9mm	Reference	Unit Price
3NO	25	4	A9C20833	1,052,700
3NO	40	6	A9C20843	1,683,000
3NO	63	6	A9C20863	2,524,500

Contactor iCT, 4P, coil voltage 24VAC

Type	Current (A)	Width in mod. of 9mm	Reference	Unit Price
4NO	25	4	A9C20134	1,411,300
4NC	25	4	A9C20137	1,612,600
4NO	63	6	A9C20164	3,385,800
4NC	63	6	A9C20167	3,868,700

Contactor iCT, 4P, coil volatge 230/240VAC

Type	Current (A)	Width in mod. of 9mm	Reference	Unit Price
4NO	25	4	A9C20834	1,226,500
4NC	25	4	A9C20837	1,402,500
2NO+2NC	25	4	A9C20838	1,314,500
4NO	40	6	A9C20844	1,865,600
4NC	40	6	A9C20847	2,242,900
4NO	63	6	A9C20864	2,803,900
4NC	63	6	A9C20867	3,364,900
2NO+2NC	63	6	A9C20868	3,155,900
4NO	100	12	A9C20884	7,973,900

Accessories - Spacer (Bag of 5)

Width in mod. of 9mm	Reference	Unit Price
1	A9A27062	380,600

When contactor are mounted in enclosures with an internal temperature of between 50 and 60°C, a spacer must be placed between each contactor

Phải sử dụng spacer giữa các contactor khi contactor được sử dụng trong tủ có nhiệt độ từ 50 và 60°C.

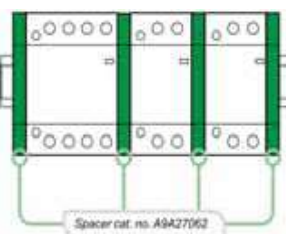

Ứng dụng	Industrial:	Domestic
	IEC 60947.4	IEC 61095
Motor	AC3	AC7b
Heating	AC1	AC7a
Lighting	AC5a and b	AC5a and b

Impulse iTL

Remote control of circuit via impulse orders
 Direct manual operation on front face
 Mechanical on-off indication through toggle
 Maximum switching frequency: 5 operations/min
 Coil voltage 230/240 VAC or 110VDC (for other voltage, please consult us)

Isolating switch iSW

Isolating switch 20 to 100A.

Impulse iTL

Điều khiển từ xa mạch điện bằng tín hiệu xung
 Có thể thao tác đóng cắt trực tiếp bằng tay từ mặt trước thiết bị
 Chỉ thị vị trí on-off bằng cần gạt
 Tần số đóng cắt lớn nhất cho phép: 5 lần/phút
 Điện áp cuộn dây 230/240 VAC hoặc 110VDC (các điện áp khác xin vui lòng liên hệ với chúng tôi)

Bộ ngắt cách ly iSW

Bộ ngắt cách ly từ 20 đến 100A.



iTL 2P

Unit price (incl.VAT) in VND

Acti 9 Impulse relay, Type iTL, on-off switch

Rating	Pole	Reference	Unit Price
16	1P	A9C30811	458,700
16	2P	A9C30812	697,400
32	1P	A9C30831	844,800

Acti 9 Impulse relay, Type iTLI, changeover switch

Rating	Pole	Reference	Unit Price
16	1P	A9C30815	942,700

Acti 9 extension for iTL, iTLI

Rating	Pole	Reference	Unit Price
16	2P	A9C32816	1,111,000
32	1P	A9C32836	844,800

Acti 9 Impulse relay, Type iTLc/iTLs

Type	Pole	Description	Rating (A)	Reference	Unit Price
iTLc	1P	Centralized control of a set of impulse relays while keeping the availability of local control	16	A9C33811	1,163,800
iTLs	1P	on-off switch, 1 pole with 6A C/O aux. contact	16	A9C32811	844,800

Acti 9 Time delay relays

Type	Description	Adjustable	Reference	Unit Price
iRTA	Delays energizing of a load	0.1s to 100h	A9E16065	1,822,700
iRTB	Delays de-energizing a load upon closing of an auxiliary contact (push button)	0.1s to 100h	A9E16066	2,187,900
iRTC	Delays de-energizing a load upon opening of an auxiliary contact (push button)	0.1s to 100h	A9E16067	2,187,900
iRTH	Applies a time delay to de-energizing of a load	0.1s to 100h	A9E16068	2,187,900
iRTL	Applies a time delay to energizing and de-energizing of a load during different times, repeatedly (flasher)	0.1s to 100h	A9E16069	2,279,200



iRTA

Acti 9 iSW Isolating Switch, 1P, 2P, 3P & 4P**Acti 9 iSW Isolating Switch, 1P & 2P**

Rating (A)	Voltage (VAC)	Reference	1P	Unit Price	Reference	2P	Unit Price
20	240	A9S60120		212,300	A9S60220		350,900
32	240	A9S60132		267,300	A9S60232		419,100
63	240	A9S65163		511,500	A9S65263		767,800
100	240	A9S65191		1,386,000	A9S65291		2,081,200

Acti 9 iSW Isolating Switch, 3P & 4P

Rating (A)	Voltage (VAC)	Reference	3P	Unit Price	Reference	4P	Unit Price
32	415	A9S60332		640,200	A9S60432		826,100
63	415	A9S65363		1,290,300	A9S65463		1,667,600
100	415	A9S65391		3,328,600	A9S65491		4,514,400



iSW 2P

STI isolatable fuse-carriers:

Provide overload and short circuit protection
Used in tertiary and industrial sectors
Can be used with fuse link aM, gG (gl, gL) types.
Complies with standard IEC 947.3.

Time Switch - IH/IHP

- IH mechanical time switch
- IHP digital time switch

IC Light sensitive switch

Light sensitive switch closing of contact when brightness decrease and drop below the selected threshold. They control opening of a contact when brightness increase and rises above the selected threshold

Cầu chì cách ly STI :

Bảo vệ quá tải và ngắn mạch
Được sử dụng trong các lĩnh vực công nghiệp.
Được dùng với các ống chì loại aM, gG (gl-GL).
Tuân theo tiêu chuẩn IEC 947.3.

Bộ đóng ngắt hẹn giờ

- IH bộ đóng ngắt hẹn giờ bằng cơ khí
- IHP bộ đóng ngắt hẹn giờ bằng kỹ thuật số

IC Cảm biến ánh sáng

Công tắc cảm biến ánh sáng đóng tiếp điểm khi độ sáng giảm và xuống thấp hơn ngưỡng chọn. Và mở tiếp điểm khi độ sáng tăng và vượt qua ngưỡng chọn.



Unit price (incl.VAT) in VND

Acti 9 - STI isolatable fuse-carrier, 500V

Type	Dimension(mm)	Reference	Unit Price
1P	10.3 x 38	A9N15636	125,400
1P+N	10.3 x 38	A9N15646	181,500
2P	10.3 x 38	A9N15651	239,800
3P	10.3 x 38	A9N15656	400,400
3P+N	10.3 x 38	A9N15658	415,800



CCT15850

Time switch, 230VAC

Type	No. of channel	No of switching operations	Saving on mains cut off	Override Input	Rating (A)	Reference	Unit Price
24hrs and/ or 7days	1	56	6 years		16	CCT15850	3,928,100
	2	56	6 years		16	CCT15852	4,771,800
7days	1	84	6 years	1	16	CCT15851	6,812,300
	2	84	6 years	2	16	CCT15853	6,282,100
24hrs	1	48	200 hours		16	CCT15365	2,957,900
	1 set of 20 riders (5 each of red, green, white and yellow)					15341	89,100



CCT15365

IC light sensitive switches, 220/240VAC (included cell)

Type	Adjustable brightness threshold	Type of cell	Reference	Unit Price
IC2000	2 to 200 lux	Switchboard cell	CCT15284	4,890,600
		Wall-mounted cell	CCT15368	6,395,400
Switch board cell	Spare photocells		15281	1,593,900
Wall mounted cell	Spare photocells		CCT15268	2,656,500

Example: Automatic controlling of bells, lighting: bells sounding the resumption and finish of work (channel 1), lighting of premises (channel 2).



IC2000

	Monday	Tuesday	Wednesday	Thursday	Friday	Saturday	Sunday
Channel: 1 bell (20s pulse order)							
On	8h00	8h00	8h00	8h00	8h00	9h00	-
Duratinon	20s	20s	20s	20s	20s	20s	-
On	12h00	12h00	12h00	12h00	11h00	13h00	-
Duratinon	20s	20s	20s	20s	20s	20s	-
On	14h00	14h00	14h00	14h00	14h00	-	-
Duratinon	20s	20s	20s	20s	20s	20s	-
On	18h00	18h00	18h00	18h00	16h00	-	-
Duratinon	20s	20s	20s	20s	20s	20s	-
Channel 2: lighting (lached order)							
On	7h30	7h30	7 h 30	7h30	6h30	8h30	-
Off	18h30	18h30	18h30	18h30	17h30	13h30	-

EasyPact EZC Range

EasyPact 100 molded case circuit breakers
Compliance with IEC 947-2, JIS C 8201, NEMA AB1
Breaking capacity at 240V: 18, 25, 50kA
Breaking capacity at 415V: 7.5, 10, 15, 30kA
Thermal and magnetic protection
15 up to 100A fixed devices

EasyPact EZC 100

MCCB EasyPact 100
Phù hợp với tiêu chuẩn IEC 947-2, JIS C 8201, NEMA AB1
Khả năng ngắt dòng ngắn mạch tại 240V: 18, 25, 50kA
Khả năng ngắt dòng ngắn mạch tại 415V: 7.5, 10, 15, 30kA
Bảo vệ theo nguyên lý nhiệt từ
15 - 100A loại cố định

Unit price (incl.VAT) in VND

EasyPact EZC 100, Type B & F, 3P



Rating	Reference		Unit Price	
	3P, Icu=7.5 kA/415 VAC		3P, Icu=10 kA/415 VAC	
15A	EZC100B3015	1,543,300	EZC100F3015	1,608,200
20A	EZC100B3020	1,543,300	EZC100F3020	1,608,200
25A	EZC100B3025	1,543,300	EZC100F3025	1,608,200
30A	EZC100B3030	1,543,300	EZC100F3030	1,608,200
40A	EZC100B3040	1,543,300	EZC100F3040	1,608,200
50A	EZC100B3050	1,543,300	EZC100F3050	1,608,200
60A	EZC100B3060	1,641,200	EZC100F3060	1,778,700
75A	-	-	EZC100F3075	1,778,700
80A	-	-	EZC100F3080	1,778,700
100A	-	-	EZC100F3100	1,944,800

EasyPact EZC 100, Type N, 1P, 3P & 4P



Rating	Reference		Unit Price		Reference		Unit Price	
	1P, Icu= 18 kA, 220/240 VAC		3P, Icu=15 kA/415 VAC		4P, Icu=15 kA/415 VAC			
15A	EZC100N1015	1,156,100	EZC100N3015	2,114,200	EZC100N4015	3,116,300		
20A	EZC100N1020	1,156,100	EZC100N3020	2,114,200	EZC100N4020	3,116,300		
25A	EZC100N1025	1,156,100	EZC100N3025	2,114,200	EZC100N4025	3,116,300		
30A	EZC100N1030	1,156,100	EZC100N3030	2,114,200	EZC100N4030	3,160,300		
40A	EZC100N1040	1,156,100	EZC100N3040	2,114,200	EZC100N4040	3,160,300		
50A	EZC100N1050	1,156,100	EZC100N3050	2,114,200	EZC100N4050	3,160,300		
60A	EZC100N1060	1,237,500	EZC100N3060	2,311,100	EZC100N4060	3,160,300		
75A	EZC100N1075	1,237,500	EZC100N3075	2,311,100	EZC100N4075	3,160,300		
80A	EZC100N1080	1,237,500	EZC100N3080	2,311,100	EZC100N4080	3,160,300		
100A	EZC100N1100	1,237,500	EZC100N3100	2,311,100	EZC100N4100	3,160,300		

EasyPact EZC 100, Type H, 1P, 2P & 3P



Rating	Reference		Unit Price		Reference		Unit Price	
	1P, Icu=25kA, 220/240 VAC		2P, Icu=50kA, 220/240 VAC		3P, Icu=30kA/415 VAC			
15A	EZC100H1015	1,446,500	EZC100H2015	1,940,400	EZC100H3015	2,684,000		
20A	EZC100H1020	1,446,500	EZC100H2020	1,940,400	EZC100H3020	2,684,000		
25A	EZC100H1025	1,446,500	EZC100H2025	1,940,400	EZC100H3025	2,684,000		
30A	EZC100H1030	1,446,500	EZC100H2030	1,940,400	EZC100H3030	2,684,000		
40A	EZC100H1040	1,446,500	EZC100H2040	1,940,400	EZC100H3040	2,684,000		
50A	EZC100H1050	1,446,500	EZC100H2050	1,940,400	EZC100H3050	2,684,000		
60A	EZC100H1060	1,547,700	EZC100H2060	2,128,500	EZC100H3060	2,951,300		
75A	EZC100H1075	1,547,700	EZC100H2075	2,128,500	EZC100H3075	2,951,300		
80A	EZC100H1080	1,547,700	EZC100H2080	2,128,500	EZC100H3080	2,951,300		
100A	EZC100H1100	1,547,700	EZC100H2100	2,128,500	EZC100H3100	2,951,300		

EasyPact EZC 100, Type H, 4P



Rating	Reference		Unit Price	
	4P, Icu=30kA/415 VAC			
15A	EZC100H4015	3,212,000		
20A	EZC100H4020	3,212,000		
25A	EZC100H4025	3,212,000		
30A	EZC100H4030	3,239,500		
40A	EZC100H4040	3,239,500		
50A	EZC100H4050	3,239,500		
60A	EZC100H4060	3,259,300		
75A	EZC100H4075	3,259,300		
80A	EZC100H4080	3,259,300		
100A	EZC100H4100	3,259,300		

EasyPact 100 Accessories & Auxiliaries
For 2P, 3P MCCB

Phụ kiện của MCCB EasyPact 100
Dùng cho MCCB 2P, 3P

Unit price (incl.VAT) in VND



EasyPact EZC 100 accessories & auxiliary

Description	Voltage	Reference	Unit Price
Alarm switch (AL)		EZAUX01	800,800
Auxiliary switch (AX)		EZAUX10	800,800
Auxiliary/ Alarm switch (AX/AL)		EZAUX11	1,335,400
Shunt trip	24 VDC	EZASHT024DC	1,578,500
STH	48 VDC	EZASHT048DC	1,578,500
	100-130VAC	EZASHT100AC	1,578,500
	200-277VAC	EZASHT200AC	1,578,500
	380-480VAC	EZASHT380AC	1,578,500
Under Voltage release	24 VDC	EZAUVR024DC	2,060,300
	110-130VAC	EZAUVR110AC	2,060,300
	380-415VAC	EZAUVR380AC	2,060,300
Din rail adapter		EZADINR	122,100
Direct rotary handle		EZAROTDS	1,205,600
Extended rotary handle		EZAROTE	2,086,700
Padlock attachment		EZALOCK	196,900
Phase barrier (set of 2 pcs)		EZAFASB2	136,400
Terminal shield 3P (set of 2 pcs)		EZATSHD3P	231,000



EasyPact 250 molded case circuit breakers
 Compliance with IEC 947-2, JIS C 8201, NEMA AB1
 Breaking capacity at 415V: 18, 25, 36kA
 Non adjustable thermal and magnetic protection
 100 up to 250A fixed devices

MCCB EasyPact 250
 Phù hợp với tiêu chuẩn IEC 947-2, JIS C 8201, NEMA AB1
 Khả năng ngắt dòng ngắn mạch tại 415V: 18, 25, 36kA
 Bảo vệ theo nguyên lý nhiệt từ
 100 - 250A loại cố định

Unit price (incl.VAT) in VND

EasyPact EZC 250, Type F, 3P

Rating	Reference	Unit Price
	3P, Icu=18 kA/415 VAC	
100A	EZC250F3100	3,580,500
125A	EZC250F3125	3,829,100
150A	EZC250F3150	4,677,200
160A	EZC250F3160	4,677,200
175A	EZC250F3175	4,939,000
200A	EZC250F3200	5,370,200
225A	EZC250F3225	5,370,200
250A	EZC250F3250	5,370,200



EasyPact EZC 250, Type N, 3P & 4P

Rating	Reference	Unit Price	Reference	Unit Price
	3P, Icu=25kA/415 VAC		4P, Icu=25kA/415 VAC	
63A	-	-	EZC250N4063	4,837,800
80A	-	-	EZC250N4080	4,837,800
100A	EZC250N3100	3,732,300	EZC250N4100	4,837,800
125A	EZC250N3125	4,204,200	EZC250N4125	6,069,800
150A	EZC250N3150	5,131,500	EZC250N4150	7,283,100
160A	EZC250N3160	5,131,500	EZC250N4160	7,283,100
175A	EZC250N3175	5,324,000	EZC250N4175	7,891,400
200A	EZC250N3200	6,059,900	EZC250N4200	8,036,600
225A	EZC250N3225	6,059,900	EZC250N4225	8,036,600
250A	EZC250N3250	6,059,900	EZC250N4250	8,036,600



EasyPact EZC 250, Type H, 2P, 3P & 4P

Rating	Reference	Unit Price	Reference	Unit Price	Reference	Unit Price
	2P, Icu=85kA, 220/240 VAC		3P, Icu=36kA/415 VAC		4P, Icu=36kA/415 VAC	
63A	-	-	-	-	EZC250H4063	5,100,700
80A	-	-	-	-	EZC250H4080	5,100,700
100A	EZC250H2100	3,705,900	EZC250H3100	3,829,100	EZC250H4100	5,100,700
125A	EZC250H2125	3,821,400	EZC250H3125	4,544,100	EZC250H4125	6,167,700
150A	EZC250H2150	4,688,200	EZC250H3150	5,571,500	EZC250H4150	7,667,000
160A	EZC250H2160	4,688,200	EZC250H3160	5,571,500	EZC250H4160	7,667,000
175A	EZC250H2175	5,659,500	EZC250H3175	6,727,600	EZC250H4175	9,029,900
200A	EZC250H2200	5,659,500	EZC250H3200	6,727,600	EZC250H4200	9,410,500
225A	EZC250H2225	5,659,500	EZC250H3225	6,727,600	EZC250H4225	9,410,500
250A	EZC250H2250	5,659,500	EZC250H3250	6,727,600	EZC250H4250	9,410,500

EasyPact EZCV250 MCCB built-in earth leakage protection
 Compliance with IEC 947-2, JIS C 8201, NEMA AB1
 Breaking capacity at 415V: 25, 36kA
 Non adjustable thermal and magnetic protection
 63 up to 250A fixed devices
 0,1/0,3/0,5/1A adjustable sensitivity
 Earth-leakage circuit breakers with three built-in protections:
 + overload
 + short-circuit
 + earth-leakage.

MCCB EasyPact EZCV250 được tích hợp thiết bị chống dòng rò.
 Phù hợp với tiêu chuẩn IEC 947-2, JIS C 8201, NEMA AB1
 Khả năng ngắt dòng ngắn mạch tại 415V: 25, 36kA
 Bảo vệ theo nguyên lý nhiệt từ
 63 - 250A loại cố định
 Dòng rò có thể điều chỉnh được: 0,1/0,3/0,5/1A
 EasyPact EZCV tích hợp các chức năng bảo vệ trong cùng một module:
 + Quá tải
 + Ngắn mạch
 + Chống dòng rò

Unit price (incl.VAT) in VND

EasyPact EZCV250 , type N, 3P&4P, Icu=25kA/ 415 VAC

Rating (A)	Sensitivity I Δ n (A)	Reference 3P	Unit Price	Reference 4P	Unit Price
63	adjustable	EZCV250N3063	9,031,000	EZCV250N4063	11,554,400
80	0,1 - 1A	EZCV250N3080	9,031,000	EZCV250N4080	11,554,400
100		EZCV250N3100	9,031,000	EZCV250N4100	11,554,400
125		EZCV250N3125	9,454,500	EZCV250N4125	13,358,400
150		EZCV250N3150	11,051,700	EZCV250N4150	15,208,600
160		EZCV250N3160	11,051,700	EZCV250N4160	15,208,600
175		EZCV250N3175	11,973,500	EZCV250N4175	17,639,600
200		EZCV250N3200	13,040,500	EZCV250N4200	19,262,100
225		EZCV250N3225	13,040,500	EZCV250N4225	19,262,100
250		EZCV250N3250	13,040,500	EZCV250N4250	19,262,100



EasyPact EZCV250, type H, 3P&4P, Icu=36kA/415 VAC

Rating (A)	Sensitivity I Δ n (A)	Reference 3P	Unit Price	Reference 4P	Unit Price
63	adjustable	EZCV250H3063	10,047,400	EZCV250H4063	12,560,900
80	0,1 - 1A	EZCV250H3080	10,047,400	EZCV250H4080	12,560,900
100		EZCV250H3100	10,047,400	EZCV250H4100	12,560,900
125		EZCV250H3125	11,693,000	EZCV250H4125	14,614,600
150		EZCV250H3150	13,885,300	EZCV250H4150	16,440,600
160		EZCV250H3160	13,885,300	EZCV250H4160	16,440,600
175		EZCV250H3175	17,162,200	EZCV250H4175	21,382,900
200		EZCV250H3200	17,162,200	EZCV250H4200	21,382,900
225		EZCV250H3225	17,162,200	EZCV250H4225	21,382,900
250		EZCV250H3250	17,162,200	EZCV250H4250	21,382,900



For accessories of EZCV250, please consult us

Trường hợp có nhu cầu về phụ kiện của EZCV250, vui lòng liên hệ với chúng tôi

EasyPact EZC 250 Accessories & Auxiliaries
For 2P, 3P, 4P MCCB

Phụ kiện của MCCB EasyPact 250
Dùng cho MCCB 2P,3P, 4P

Unit price (incl.VAT) in VND

EasyPact 250 accessories & auxiliary



Description		Reference	Unit Price
Alarm Switch AL		EZEAL	762,300
Auxiliary Switch AX		EZEAX	762,300
Auxiliary & Alarm Switch (AX & AL)		EZEAXAL	1,269,400
Shunt trip (STH)	24 VDC	EZESHT024DC	1,536,700
	48 VDC	EZESHT048DC	1,536,700
	100-120 VAC	EZESHT100AC	1,536,700
	120-130 VAC	EZESHT120AC	1,536,700
	200-240 VAC	EZESHT200AC	1,536,700
	380-440 VAC	EZESHT400AC	1,536,700
Under Voltage release (UVR)	440-480 VAC	EZESHT440AC	1,826,000
	24 VDC	EZEUVR024DC	5,423,000
	48 VDC	EZEUVR048DC	5,423,000
	110-130 VAC	EZEUVR110AC	5,423,000
	125 VDC	EZEUVR125DC	5,423,000
	200-240 VAC	EZEUVR200AC	5,423,000
Under Voltage release (UVRN) (only EZC250-4P)	277 VAC	EZEUVR277AC	5,423,000
	380-415VAC	EZEUVR400AC	5,423,000
	440-480VAC	EZEUVR440AC	5,423,000
	24 VDC	EZEUVRN024DC	5,909,200
	48 VDC	EZEUVRN048DC	5,909,200
	125 VDC	EZEUVRN125DC	5,909,200
Phase barrier (set of 2 pcs)	110-130 VAC	EZEUVRN110AC	5,909,200
	200-240 VAC	EZEUVRN200AC	7,034,500
	277 VAC	EZEUVRN277AC	6,870,600
	380-415 VAC	EZEUVRN400AC	8,244,500
Padlock attachment (for EZC250-3P)	440-480 VAC	EZEUVRN440AC	8,244,500
		EZEFASB2	122,100
Padlock attachment (for EZC250-4P)		EZELOCK	184,800
Direct rotary handle		EZELOCKN	184,800
Extended rotary handle		EZEROTDS	1,438,800
Terminal extension for 3P (set of 3pcs)		EZEROTE	2,456,300
Terminal extension for 4P (set of 4)		EZETEX	254,100
Spreader for 3P		EZETEX4P	498,300
Terminal shield 3P (set of 2pcs)		EZESPDR3P	281,600
		EZETSHD3P	281,600

EasyPact 400 molded case circuit breakers
 Compliance with IEC 947-2, JIS C 8201, NEMA AB1
 Breaking capacity at 415V: 36, 50kA
 Non adjustable thermal and magnetic protection
 320 up to 600A fixed devices
 Use same accessories with EasyPact CVS

MCCB EasyPact 400
 Phù hợp với tiêu chuẩn IEC 947-2, JIS C 8201, NEMA AB1
 Khả năng ngắt dòng ngắn mạch tại 415V: 36, 50kA
 Bảo vệ theo nguyên lý nhiệt từ
 320 - 600A loại cố định
 Dùng chung phụ kiện với EasyPact CVS



Unit price (incl.VAT) in VND

EasyPact Ezc 400/630 type N, 3P&4P, Icu=36kA 415 VAC

Rating, In(A)	Reference 3P	Unit Price	Reference 4P	Unit Price
320	EZC400N3320N	8,028,900	EZC400N4320N	9,648,100
350	EZC400N3350N	8,028,900	EZC400N4350N	9,648,100
400	EZC400N3400N	8,028,900	EZC400N4400N	10,032,000
400	EZC630N3400N	9,730,600	EZC630N4400N	13,620,200
500	EZC630N3500N	9,730,600	EZC630N4500N	13,620,200
600	EZC630N3600N	9,730,600	EZC630N4600N	13,620,200

EasyPact Ezc 400/630 type H, 3P&4P, Icu=50kA 415 VAC

Rating, In(A)	Reference 3P	Unit Price	Reference 4P	Unit Price
320	EZC400H3320N	8,814,300	EZC400H4320N	10,323,500
350	EZC400H3350N	8,814,300	EZC400H4350N	10,323,500
400	EZC400H3400N	8,814,300	EZC400H4400N	10,734,900
400	EZC630H3400N	10,897,700	EZC630H4400N	14,573,900
500	EZC630H3500N	10,897,700	EZC630H4500N	14,573,900
600	EZC630H3600N	10,897,700	EZC630H4600N	14,573,900

Electrical auxiliaries for EasyPact 400/630



		Reference	Unit Price
Auxiliary switch	OF, SD or SDE or SDV	29450	765,600
Shunt trip (MX)	AC 50/60Hz	LV429385	1,692,900
	220/240	LV429387	1,692,900
	380/415	LV429388	1,692,900
	DC	LV429390	1,692,900
	48	LV429392	1,692,900
	125	LV429393	2,329,800
	250	LV429394	2,329,800
	Under voltage (MN)	AC 50/60Hz	LV429404
	220/240	LV429407	2,455,200
	380/415	LV429408	2,455,200
	24	LV429410	1,588,400
	48	LV429412	1,657,700
Rotary handle	250	LV429414	1,855,700
	Direct rotary handle	LV432597	2,063,600
	Extended rotary handles	LV432598	3,581,600
Locks	Toggle locking device for 1 to 3 padlocks (removeable)	29370	291,500
	Toggle locking device for 1 to 3 padlocks (fixed)	LV432631	748,000
	Locking of rotary handle	Keylock adapter	LV432604
	Keylock (Ronis)	41940	1,653,300
Interphase barriers	set of 6	LV432570	541,200

Molded Case Circuit Breaker

Easypact CVS fixed B,F,N type

Easypact CVS molded case circuit breakers

Compliance with IEC 947-2

Adjustable trip unit from 0.7 to 1 (TMD)

Rated current from 16A to 600A

Some accessories same with Compact NSX

MCCB Easypact CVS

Phù hợp với tiêu chuẩn IEC 947-2

Trip unit có thể chỉnh định được từ 0.7 đến 1 (TMD)

Dòng định mức từ 16A đến 600A

Một số phụ kiện dùng chung với Compact NSX

Unit price (incl.VAT) in VND

Easypact CVS100/250 fixed, B type, equipped with TMD trip unit, Icu = 25kA/415V

Type	Rating @ 40°C	Reference	3P	Unit Price	Reference	4P	Unit Price
CVS100B	16	LV510300		2,851,200	LV510310		3,809,300
	25	LV510301		2,851,200	LV510311		3,809,300
	32	LV510302		2,851,200	LV510312		3,809,300
	40	LV510303		2,851,200	LV510313		3,809,300
	50	LV510304		2,851,200	LV510314		3,809,300
	63	LV510305		2,851,200	LV510315		3,809,300
	80	LV510306		2,880,900	LV510316		4,029,300
CVS160B	100	LV510307		2,880,900	LV510317		4,029,300
	125	LV516302		3,644,300	LV516312		5,481,300
CVS250B	160	LV516303		4,633,200	LV516313		6,238,100
	200	LV525302		5,410,900	LV525312		7,486,600
	250	LV525303		6,068,700	LV525313		8,485,400



Easypact CVS100/630 fixed, F type, equipped with TMD trip unit, Icu = 36kA/415V

Type	Rating @ 40°C	Reference	3P	Unit Price	Reference	4P	Unit Price
CVS100F	16	LV510330		2,960,100	LV510340		4,109,600
	25	LV510331		2,960,100	LV510341		4,109,600
	32	LV510332		2,960,100	LV510342		4,109,600
	40	LV510333		2,960,100	LV510343		4,109,600
	50	LV510334		2,960,100	LV510344		4,109,600
	63	LV510335		2,960,100	LV510345		4,109,600
	80	LV510336		3,070,100	LV510346		4,385,700
CVS160F	100	LV510337		3,070,100	LV510347		4,385,700
	125	LV516332		3,946,800	LV516342		5,765,100
CVS250F	160	LV516333		4,987,400	LV516343		6,781,500
	200	LV525332		6,111,600	LV525342		8,509,600
	250	LV525333		6,827,700	LV525343		9,641,500
	320	LV540305		10,315,800	LV540308		11,943,800
CVS400F	400	LV540306		10,858,100	LV540309		13,302,300
	500	LV563305		13,979,900	LV563308		17,476,800
CVS630F	600	LV563306		16,131,500	LV563309		18,552,600



Easypact CVS400/630 fixed, N type, equipped with TMD trip unit, Icu = 50kA/415V

Type	Rating @ 40°C	Reference	3P	Unit Price	Reference	4P	Unit Price
CVS400N	320	LV540315		11,401,500	LV540318		14,386,900
	400	LV540316		12,215,500	LV540319		15,200,900
CVS630N	500	LV563315		16,131,500	LV563318		18,818,800
	600	LV563316		17,339,300	LV563319		20,432,500

Compact NSXm MCCB

- EverLink connectors
- Spring type auxiliaries externally visible
- Built-in DIN rail and plate mount capability

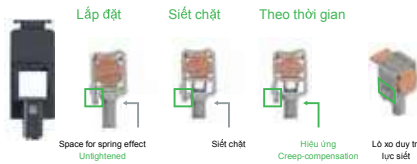

MCCB Compact NSXm

- Đầu nối dạng EverLink
- Phụ kiện dạng lò xo có thể trực quan
- Lắp đặt Built-in DIN rail và trên đế

Unit price (incl.VAT) in VND

Compact NSXm E (16kA @ 380/415V) with TMD trip unit

EverLink™ connectors

Rating	Reference	3P	Unit Price	Reference	4P	Unit Price
16	LV426100		3,777,400	LV426110		5,105,100
25	LV426101		3,777,400	LV426111		5,105,100
32	LV426102		3,777,400	LV426112		5,105,100
40	LV426103		3,777,400	LV426113		5,105,100
50	LV426104		3,777,400	LV426114		5,105,100
63	LV426105		3,777,400	LV426115		5,105,100
80	LV426106		3,885,200	LV426116		5,420,800
100	LV426107		3,885,200	LV426117		5,420,800
125	LV426108		4,911,500	LV426118		7,653,800
160	LV426109		4,911,500	LV426119		8,408,400

Compression lug/busbar connectors

16	LV426150		3,529,900	LV426160		4,770,700
25	LV426151		3,529,900	LV426161		4,770,700
32	LV426152		3,529,900	LV426162		4,770,700
40	LV426153		3,529,900	LV426163		4,770,700
50	LV426154		3,529,900	LV426164		4,770,700
63	LV426155		3,529,900	LV426165		4,770,700
80	LV426156		3,630,000	LV426166		5,065,500
100	LV426157		3,630,000	LV426167		5,065,500
125	LV426158		4,590,300	LV426168		7,153,300
160	LV426159		4,590,300	LV426169		7,858,400

Compact NSXm B (25kA @ 380/415V) with TMD trip unit

EverLink™ connectors

Rating	Reference	3P	Unit Price	Reference	4P	Unit Price
16	LV426200		3,934,700	LV426210		5,317,400
25	LV426201		3,934,700	LV426211		5,317,400
32	LV426202		3,934,700	LV426212		5,317,400
40	LV426203		3,934,700	LV426213		5,317,400
50	LV426204		3,934,700	LV426214		5,317,400
63	LV426205		3,934,700	LV426215		5,317,400
80	LV426206		4,046,900	LV426216		5,646,300
100	LV426207		4,046,900	LV426217		5,646,300
125	LV426208		5,116,100	LV426218		7,972,800
160	LV426209		5,116,100	LV426219		8,759,300

Compression lug/busbar connectors

16	LV426250		3,677,300	LV426260		4,969,800
25	LV426251		3,677,300	LV426261		4,969,800
32	LV426252		3,677,300	LV426262		4,969,800
40	LV426253		3,677,300	LV426263		4,969,800
50	LV426254		3,677,300	LV426264		4,969,800
63	LV426255		3,677,300	LV426265		4,969,800
80	LV426256		3,781,800	LV426266		5,276,700
100	LV426257		3,781,800	LV426267		5,276,700
125	LV426258		4,781,700	LV426268		7,451,400
160	LV426259		4,781,700	LV426269		8,186,200



Compact NSXm MCCB

- EverLink connectors
- Spring type auxiliaries externally visible
- Built-in DIN rail and plate mount capability

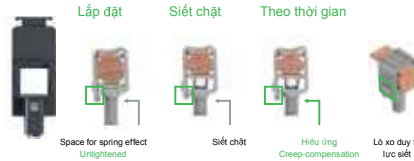

MCCB Compact NSXm

- Đầu nối dạng EverLink
- Phụ kiện dạng lò xo có thể trực quan
- Lắp đặt Built-in DIN rail và trên đế

Unit price (incl.VAT) in VND

Compact NSXm F (36kA @ 380/415V) with TMD trip unit

EverLink™ connectors

Rating	Reference	3P	Unit Price	Reference	4P	Unit Price
16	LV426300		4,142,600	LV426310		5,652,900
25	LV426301		4,142,600	LV426311		5,652,900
32	LV426302		4,142,600	LV426312		5,652,900
40	LV426303		4,142,600	LV426313		5,652,900
50	LV426304		4,142,600	LV426314		5,652,900
63	LV426305		4,142,600	LV426315		5,652,900
80	LV426306		4,259,200	LV426316		6,002,700
100	LV426307		4,259,200	LV426317		6,002,700
125	LV426308		5,504,400	LV426318		8,092,700
160	LV426309		6,990,500	LV426319		9,518,300

Compression lug/busbar connectors

16	LV426350		3,872,000	LV426360		5,283,300
25	LV426351		3,872,000	LV426361		5,283,300
32	LV426352		3,872,000	LV426362		5,283,300
40	LV426353		3,872,000	LV426363		5,283,300
50	LV426354		3,872,000	LV426364		5,283,300
63	LV426355		3,872,000	LV426365		5,283,300
80	LV426356		3,980,900	LV426366		5,610,000
100	LV426357		3,980,900	LV426367		5,610,000
125	LV426358		5,144,700	LV426368		7,563,600
160	LV426359		6,532,900	LV426369		8,895,700

Compact NSXm N (50kA @ 380/415V) with TMD trip unit

EverLink™ connectors

Rating	Reference	3P	Unit Price	Reference	4P	Unit Price
16	LV426400		4,735,500	LV426410		6,395,400
25	LV426401		4,735,500	LV426411		6,395,400
32	LV426402		4,735,500	LV426412		6,395,400
40	LV426403		4,735,500	LV426413		6,395,400
50	LV426404		4,735,500	LV426414		6,395,400
63	LV426405		4,735,500	LV426415		6,395,400
80	LV426406		4,865,300	LV426416		6,788,100
100	LV426407		4,865,300	LV426417		6,788,100
125	LV426408		6,058,800	LV426418		8,911,100
160	LV426409		7,694,500	LV426419		10,479,700

Compression lug/busbar connectors

16	LV426450		4,425,300	LV426460		5,977,400
25	LV426451		4,425,300	LV426461		5,977,400
32	LV426452		4,425,300	LV426462		5,977,400
40	LV426453		4,425,300	LV426463		5,977,400
50	LV426454		4,425,300	LV426464		5,977,400
63	LV426455		4,425,300	LV426465		5,977,400
80	LV426456		4,547,400	LV426466		6,343,700
100	LV426457		4,547,400	LV426467		6,343,700
125	LV426458		5,662,800	LV426468		8,328,100
160	LV426459		7,190,700	LV426469		9,794,400



Compact NSXm MCCB

- EverLink connectors
- Spring type auxiliaries externally visible
- Built-in DIN rail and plate mount capability

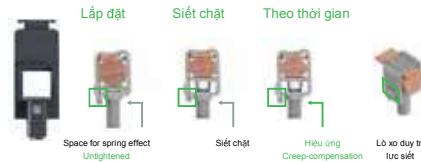

MCCB Compact NSXm

- Đầu nối dạng EverLink
- Phụ kiện dạng lò xo có thể trực quan
- Lắp đặt Built-in DIN rail và trên đế

Unit price (incl.VAT) in VND

Compact NSXm H (70kA @ 380/415V) with TMD trip unit

EverLink™ connectors

Rating	Reference	3P	Unit Price	Reference	4P	Unit Price
16	LV426500		5,269,000	LV426510		7,415,100
25	LV426501		5,269,000	LV426511		7,415,100
32	LV426502		5,269,000	LV426512		7,415,100
40	LV426503		5,269,000	LV426513		7,415,100
50	LV426504		5,269,000	LV426514		7,415,100
63	LV426505		5,269,000	LV426515		7,415,100
80	LV426506		5,487,900	LV426516		7,889,200
100	LV426507		5,487,900	LV426517		7,889,200
125	LV426508		7,792,400	LV426518		10,442,300
160	LV426509		9,463,300	LV426519		11,908,600

Compression lug/busbar connectors

16	LV426550	4,924,700	LV426560	6,930,000
25	LV426551	4,924,700	LV426561	6,930,000
32	LV426552	4,924,700	LV426562	6,930,000
40	LV426553	4,924,700	LV426563	6,930,000
50	LV426554	4,924,700	LV426564	6,930,000
63	LV426555	4,924,700	LV426565	6,930,000
80	LV426556	5,129,300	LV426566	7,373,300
100	LV426557	5,129,300	LV426567	7,373,300
125	LV426558	7,283,100	LV426568	9,759,200
160	LV426559	8,844,000	LV426569	11,129,800

Compact NSXm Auxiliaries

			Reference	Unit Price	
Auxiliary contacts (changeover)	Standard OF or SD		LV426950	750,200	
AC	Voltages	MX	MN		
	110...130 V 50HZ	LV426843	3,518,900	LV426803	3,518,900
	220...240 V 50 Hz	LV426844	3,518,900	LV426804	3,518,900
	380...415 V 50 HZ	LV426846	3,518,900	LV426806	3,518,900
DC	250 V DC	LV426844	3,518,900	LV426815	3,518,900
Direct rotary handle			LV426930	2,029,500	
Extended rotary handle			LV426932	2,327,600	
Open door shaft operator			LV426937	1,114,300	
Lateral rotary handle			LV426935	2,158,200	
CB fixed handle padlock ON/OFF			LV426905	935,000	



Molded Case Circuit Breaker

Compact NSX molded case circuit breakers
Compliance with IEC 947-2
Available for so many types of trip unit:
MA, TMD and Micrologic 1, 2, 5/6 A or E trip unit
from 100 to 630A
Easy to communication

Compact NSX fixed B/F type

MCCB Compact NSX
Phù hợp với tiêu chuẩn IEC 947-2
Có nhiều loại trip unit: MA (bảo vệ từ), TMD (từ nhiệt)
và Micrologic 1, 2, 5/6 A hoặc E
cho dây sản phẩm từ 100A đến 630A
Truyền thông dễ dàng

Unit price (incl.VAT) in VND

Compact NSX100/160/250B equipped with TMD trip unit, Icu=25kA 415V

Type	Rating	Reference	3P	Unit Price	Reference	4P	Unit Price
Compact NSX 100B	16	LV429557		3,997,400	LV429567		5,402,100
	25	LV429556		3,997,400	LV429566		5,402,100
	32	LV429555		3,997,400	LV429565		5,402,100
	40	LV429554		3,997,400	LV429564		5,402,100
	50	LV429553		3,997,400	LV429563		5,402,100
	63	LV429552		3,997,400	LV429562		5,402,100
	80	LV429551		4,110,700	LV429561		5,735,400
Compact NSX 160B	100	LV429550		4,110,700	LV429560		5,735,400
	125	LV430311		5,197,500	LV430321		8,099,300
Compact NSX 250B	160	LV430310		6,596,700	LV430320		8,897,900
	200	LV431111		7,718,700	LV431121		10,676,600
	250	LV431110		8,653,700	LV431120		12,102,200

Compact NSX100/160/250F equipped with TMD trip unit, Compact NSX400/630F equipped with Micrologic 2,3, Icu=36kA 415V

Type	Rating	Reference	3P	Unit Price	Reference	4P	Unit Price
Compact NSX 100F	16	LV429637		4,208,600	LV429647		5,743,100
	25	LV429636		4,208,600	LV429646		5,743,100
	32	LV429635		4,208,600	LV429645		5,743,100
	40	LV429634		4,208,600	LV429644		5,743,100
	50	LV429633		4,208,600	LV429643		5,743,100
	63	LV429632		4,208,600	LV429642		5,743,100
	80	LV429631		4,327,400	LV429641		6,097,300
Compact NSX 160F	100	LV429630		4,327,400	LV429640		6,097,300
	125	LV430631		5,592,400	LV430641		8,221,400
Compact NSX 250F	160	LV430630		7,100,500	LV430640		9,669,000
	200	LV431631		8,684,500	LV431641		12,133,000
	250	LV431630		9,737,200	LV431640		13,751,100
Compact NSX 400F	400	LV432676		15,948,900	LV432677		19,778,000
Compact NSX 630F	630	LV432876		24,577,300	LV432877		29,011,400

For circuit breaker equipped electronic trip unit Micrologic 5/6 A or E, or MA trip unit motor protection, please consult us
Trường hợp có nhu cầu về CB có trang bị trip điện tử Micrologic 5/6 A hoặc E, hoặc loại MA trip unit bảo vệ động cơ,
liên hệ với chúng tôi



Molded Case Circuit Breaker

Compact NSX fixed N/H type

Compact NSX molded case circuit breakers
Compliance with IEC 947-2
Available for so many types of trip unit:
MA, TMD and Micrologic 1, 2, 5/6 A or E trip unit
from 100 to 630A
Easy to communication

MCCB Compact NSX
Phù hợp với tiêu chuẩn IEC 947-2
Có nhiều loại trip unit: MA (bảo vệ từ), TMD (từ nhiệt)
và Micrologic 1, 2, 5/6 A hoặc E
cho dây sản phẩm từ 100A đến 630A
Truyền thông dễ dàng

Unit price (incl.VAT) in VND



Compact NSX100/160/250N equipped with TMD trip unit, Compact NSX400/630N equipped with Micrologic 2.3, Icu=50kA 415V

Type	Rating	Reference	3P	Unit Price	Reference	4P	Unit Price
Compact NSX 100N	16	LV429847		4,810,300	LV429857		6,496,600
	25	LV429846		4,810,300	LV429856		6,496,600
	32	LV429845		4,810,300	LV429855		6,496,600
	40	LV429844		4,810,300	LV429854		6,496,600
	50	LV429843		4,810,300	LV429853		6,496,600
	63	LV429842		4,810,300	LV429852		6,496,600
	80	LV429841		4,943,400	LV429851		6,895,900
Compact NSX 160N	100	LV429840		4,943,400	LV429850		6,895,900
	125	LV430841		6,155,600	LV430851		9,051,900
Compact NSX 250N	160	LV430840		7,815,500	LV430850		10,645,800
	200	LV431831		9,298,300	LV431841		12,991,000
Compact NSX 400N	250	LV431830		10,424,700	LV431840		14,723,500
	400	LV432693		18,526,200	LV432694		22,745,800
Compact NSX 630N	630	LV432893		26,788,300	LV432894		31,621,700



Compact NSX100/160/250H equipped with TMD trip unit, Compact NSX400/630H equipped with Micrologic 2.3, Icu=70kA 415V

Type	Rating	Reference	3P	Unit Price	Reference	4P	Unit Price
Compact NSX 100H	16	LV429677		5,352,600	LV429687		7,532,800
	25	LV429676		5,352,600	LV429686		7,532,800
	32	LV429675		5,352,600	LV429685		7,532,800
	40	LV429674		5,352,600	LV429684		7,532,800
	50	LV429673		5,352,600	LV429683		7,532,800
	63	LV429672		5,352,600	LV429682		7,532,800
	80	LV429671		5,574,800	LV429681		8,014,600
Compact NSX 160H	100	LV429670		5,574,800	LV429680		8,014,600
	125	LV430671		7,916,700	LV430681		10,607,300
Compact NSX 250H	160	LV430670		9,612,900	LV430680		12,097,800
	200	LV431671		12,530,100	LV431681		18,115,900
Compact NSX 400H	250	LV431670		12,530,100	LV431680		18,115,900
	400	LV432695		22,335,500	LV432696		27,050,100
Compact NSX 630H	630	LV432895		30,228,000	LV432896		40,464,600

- For circuit breaker equipped electronic trip unit Micrologic 5/6 A or E, or MA trip unit motor protection, please consult us
- Trường hợp có nhu cầu về CB có trang bị trip điện tử Micrologic 5/6 A hoặc E, hoặc loại MA trip unit bảo vệ động cơ, liên hệ với chúng tôi

Molded Case Circuit Breaker

Compact NSX plug-in/ drawout B/F/N/H type

Compact NSX molded case circuit breakers

Compliance with IEC 947-2

Available for so many types of trip unit:

MA, TMD and Micrologic 1, 2, 5/6 A or E trip unit

from 100 to 630A

Easy to communication

MCCB Compact NSX

Phù hợp với tiêu chuẩn IEC 947-2

Có nhiều loại trip unit: MA (bảo vệ từ), TMD (từ nhiệt)

và Micrologic 1, 2, 5/6 A hoặc E

cho dây sản phẩm từ 100A đến 630A

Truyền thông dễ dàng

Unit price (incl.VAT) in VND

Plug-in kit (*)

Type	Reference	3P Unit Price	Reference	4P Unit Price
NSX100/160/250	LV429289	4,868,600	LV429290	6,296,400
NSX400/630	LV432538	12,791,900	LV432539	14,740,000

(*) Plug-in version = fixed/FC device + Plug-in kit

Compact NSX loại Plug-in bao gồm CB loại fixed (đầu nối phía trước) và plug-in kit

Withdrawable kit (**)

Type	Rating	Reference	3P Unit Price	Reference	4P Unit Price
NSX100/160/250	Plug-in kit	LV429289	4,868,600	LV429290	6,296,400
	Chassis side plates for base	+		+	
	Chassis side plates for breaker	LV429282	4,449,500	LV429282	4,449,500
NSX400/630	Chassis side plates for breaker	LV429283	1,450,900	LV429283	1,450,900
	Plug-in kit	LV432538	12,791,900	LV432539	14,740,000
	Chassis side plates for base	+		+	
	Chassis side plates for breaker	LV432532	8,894,600	LV432532	8,894,600
		LV432533	2,079,000	LV432533	2,079,000

(**) Withdrawable version = fixed/FC device + withdrawable kit

Compact NSX loại withdrawable bao gồm CB loại fixed (đầu nối phía trước) và Withdrawable kit



Withdrawable type



Plug-in type

Earth leakage protection modules
motormechanism for remote operation
and electrical auxiliaries

Module bảo vệ chống dòng rò
Động cơ đóng cắt MCCB để điều khiển từ xa
và các phụ kiện

Unit price (incl.VAT) in VND

Motor mechanism for NSX100/160/250/400 & 630

Motor mechanism module MT100/160 and MT250 supplied with SDE adapter



Description	Operation voltage	Reference	Unit Price
MT100/160	AC 50/60Hz	220/240	LV429434 11,630,300
		380/415	LV429435 11,630,300
	DC	24/30	LV429436 33,727,100
		110	LV429438 33,727,100
MT250	AC 50/60Hz	220/240	LV429439 33,727,100
		380/440	LV431541 14,204,300
	DC	24/30	LV431542 14,204,300
		250	LV431543 33,402,600
MT400/630	AC 50/60Hz	220/240	LV431546 33,402,600
		380/440	LV432641 26,276,800
	DC	24/30	LV432642 26,276,800
		250	LV432643 33,402,600
		250	LV432646 33,402,600



Vigi module (Earth leakage protection) for NSX100 to NSX630

Type of breaker	Type	Sensitivity (A)	Pole	Reference	Unit Price
NSX100/160	MH	0.03 - 10	Adjustable	3P	LV429210 13,336,400
				4P	LV429211 15,684,900
	ME	0.3	Fixed	3P	LV429212 11,751,300
				4P	LV429213 13,811,600
NSX250	MH	0.03 - 10	Adjustable	3P	LV431535 15,786,100
				4P	LV431536 19,435,900
NSX400/630	MB	0.3 - 30	Adjustable	3P	LV432455 23,901,900
				4P	LV432456 27,515,400



Electrical auxiliaries for NSX100 to NSX630

			Reference	Unit Price
Auxiliary switch (changeover)		OF, SD, or SDE or SDV	29450	765,600
		SDE adapter, mandatory for trip unit TM, MA or Micrologic 2	LV429451	490,600
Shunt trip (MX)	AC 50/60Hz	48	LV429385	1,692,900
		220/240	LV429387	1,692,900
		380/415	LV429388	1,692,900
	DC	24	LV429390	1,692,900
		48	LV429392	1,692,900
		125	LV429393	2,329,800
Under voltage (MN)	AC 50/60Hz	250	LV429394	2,329,800
		24	LV429404	1,689,600
		220/240	LV429407	2,455,200
	DC	380/415	LV429408	2,455,200
		24	LV429410	1,588,400
		48	LV429412	1,657,700
		250	LV429414	1,855,700
	Time day	220/240 VAC	LV429427	4,045,800
SDx output module for Micrologic		24/415VAC/DC	LV429532	8,578,900
SDTAM contactor tripping module (early-break thermal fault signal) for Micrologic 2.2-M/6.2E-M			LV429424	8,804,400



Rotary handle, locking and interlocking
Connection accessories

Tay nắm kiểu xoay, khoá và khoá liên động
Phụ kiện kết nối

Unit price (incl.VAT) in VND

Compact NSX accessories - Rotary handle, locks and interlocking

Rotary handle, locks, interlocking for NSX100/160/250



Description	Type	Reference	Unit Price	
Rotary handle	Direct rotary handle	LV429337	1,127,500	
	Extended rotary handles	LV429338	2,327,600	
	Extended rotary handles with telescopic handle for withdrawable device (500mm shaft)	LV429343	3,098,700	
Locks	Toggle locking device for 1 to 3 padlocks (removable)	29370	291,500	
	Toggle locking device for 1 to 3 padlocks (fixed)	LV429371	935,000	
	Locking of rotary handle	Keylock adapter	LV429344	390,500
		Keylock (Ronis)	41940	1,653,300
Interlocking	Mechanical interlocking with toggles for circuit breaker	LV429354	3,423,200	
	with rotary handle	LV429369	5,503,300	
	Interlocking with key for rotary handle	Keylock kit	LV429344	390,500
		Keylock (Ronis)	41950	3,545,300



Rotary handle, locking, interlocking for NSX400/630



Description	Type	Reference	Unit Price	
Rotary handle	Direct rotary handle	LV432597	2,063,600	
	Extended rotary handles	LV432598	3,581,600	
	Extended rotary handles with telescopic handle for withdrawable device (500mm shaft)	LV432603	3,762,000	
Locks	Toggle locking device for 1 to 3 padlocks (removable)	29370	291,500	
	Toggle locking device for 1 to 3 padlocks (fixed)	LV432631	748,000	
	Locking of rotary handle	Keylock adapter	LV432604	573,100
		Keylock (Ronis)	41940	1,653,300
Interlocking	Mechanical interlocking with toggles for circuit breaker	LV432614	5,099,600	
	with rotary handle	LV432621	5,615,500	
	Interlocking with key for rotary handle	Keylock kit	LV432604	573,100
		Keylock (Ronis)	41950	3,545,300

Compact NSX accessories - Connection accessories

Accessories for NSX100/160/250



Description	Type	Pole	Reference	Unit Price
Rear connection	Short		LV429235	1,589,500
	Long		LV429236	1,972,300
Terminal extension	Spreader (supplied with interphase barriers)	3P	LV431563	573,100
		4P	LV431564	663,300
Terminal shields	Short (1 pcs)	3P	LV429515	127,600
		4P	LV429516	206,800
	Long (1pcs)	3P	LV429517	447,700
		4P	LV429518	492,800
	Interphase barriers	set of 6	LV429329	385,000
	25/100A external neutral CT		LV429521	8,023,400
	NS retrofit front cover (small cut-out)		LV429528	249,700
	150/250A external neutral CT		LV430563	7,570,200
	Torque limiting screws (set of 12)		LV429513	1,718,200



Accessories for NSX400/630



Description	Type	Pole	Reference	Unit Price
Rear connection	Short		LV432475	1,729,200
	Long		LV432476	3,187,800
Terminal extension	Spreader (supplied with interphase barriers)	3P	LV432490	2,096,600
		4P	LV432491	2,652,100
Terminal shields	Short (1 pcs)	3P	LV432591	563,200
		4P	LV432592	646,800
	Long (1pcs)	3P	LV432593	710,600
		4P	LV432594	777,700
	Long for spreaders, 52.5mm	3P	LV432595	1,724,800
	supplied with insulation plate	4P	LV432596	1,724,800
	Interphase barriers	set of 6	LV432570	541,200
	400/630A external neutral CT		LV432575	9,332,400
	NS retrofit front cover (small cut-out)		LV432571	873,400
	Torque limiting screws (set of 12)	set of 12	LV432513	1,733,600
	IP40 escutcheon for all control types		LV432558	1,158,300

Compact NS Range

Compact NS 630A to 3200A manually & electrical operation

Compliance with IEC 947-2

Basic manually operation CB includes front connection and Micrologic 2.0 trip unit.

Basic electrical operation CB includes

Basic frame front connection (top & bottom)

micrologic 2.0

motorise mechanism (220/240 VAC)

shunt trip MX (220/240 VAC)

Electrical auxiliary and accessories is optional

Phù hợp với tiêu chuẩn IEC 947-2

CB hoạt động bằng tay bao gồm bộ đầu dây và trip unit micrologic 2.0

CB hoạt động bằng điện bao gồm:

Thân CB bộ đầu cực (trên & dưới)

micrologic 2.0

cơ cấu motorise (220/240 VAC)

cuộn cắt MX (220/240 VAC)

Các phụ kiện cần phải đặt hàng (tùy chọn)



Unit price (incl.VAT) in VND

Compact NS fixed type manually operated

Compact NS630b to 1600, N type fixed front connection and Micrologic 2.0

Icu (415V)	Rating In (A)	Reference 3P	Unit Price	Reference 4P	Unit Price
50kA	630b	NS06bN3M2	45,325,500	NS06bN4M2	54,840,500
	800	NS080N3M2	45,325,500	NS080N4M2	57,544,300
	1000	NS100N3M2	58,054,700	NS100N4M2	69,348,400
	1250	NS125N3M2	68,666,400	NS125N4M2	83,402,000
70kA	1600b	NS160N3M2	81,823,500	NS160N4M2	104,445,000
	2000	NS200N3M2	117,453,600	NS200N4M2	139,401,900
	2500	NS250N3M2	137,029,200	NS250N4M2	171,251,300
	3200	NS320N3M2	203,008,300	NS320N4M2	237,704,500

Compact NS630b to 1600, H type fixed, front connection and Micrologic 2.0

Icu (415V)	Rating	Reference 3P	Unit Price	Reference 4P	Unit Price
70kA	630b	NS06bH3M2	51,121,400	NS06bH4M2	85,023,400
	800	NS080H3M2	55,075,900	NS080H4M2	88,501,600
	1000	NS100H3M2	63,494,200	NS100H4M2	91,264,800
	1250	NS125H3M2	75,092,600	NS125H4M2	101,350,700
85KA	1600b	NS160H3M2	98,552,300	NS160H4M2	115,776,100
	2000	NS200H3M2	129,603,100	NS200H4M2	165,657,800
	2500	NS250H3M2	153,854,800	NS250H4M2	189,149,400
	3200	NS320H3M2	222,568,500	NS320H4M2	283,671,300

For manually operation CB, the motorise mechanism can not be installed

Cơ Cấu Motor không thể lắp vào loại CB hoạt động bằng tay

Compact NS fixed type electrical operated

Compact NS630b to 1600, N type, fixed, front connection, Micrologic 2.0 and motor mechanism + MX + XF

Icu (415V)	Rating	Reference 3P	Unit Price	Reference 4P	Unit Price
50KA	630b	NS06bN3E2	103,169,000	NS06bN4E2	119,414,900
	800	NS080N3E2	107,371,000	NS080N4E2	129,174,100
	1000	NS100N3E2	110,398,200	NS100N4E2	133,058,200
	1250	NS125N3E2	135,202,100	NS125N4E2	163,199,300
1600	1600	NS160N3E2	152,042,000	NS160N4E2	185,216,900

Compact NS630b to 1600, H type, fixed, front connection and Micrologic 2.0, and motor mechanism + MX + XF

Icu (415V)	Rating	Reference 3P	Unit Price	Reference 4P	Unit Price
70KA	630b	NS06bH3E2	109,803,100	NS06bH4E2	131,176,100
	800	NS080H3E2	112,647,700	NS080H4E2	135,716,900
	1000	NS100H3E2	121,938,300	NS100H4E2	143,160,600
	1250	NS125H3E2	143,799,700	NS125H4E2	171,348,100
1600	1600	NS160H3E2	160,755,100	NS160H4E2	195,362,200

MCCB Compact NS
Complying with IEC 947-2
Withdrawable device from 630b to 1600A
Rotary handle, locking and interlocking
Connection accessories

MCCB Compact NS
Phù hợp với tiêu chuẩn IEC 947-2
Từ 630b đến 1600A loại có thể kéo ra được.
Tay nắm kiểu xoay, khoá và khoá liên động
Phụ kiện và phụ kiện kết nối

Standard	Range	Type	Voltage(VAC)	Icu(kA)
As IEC947-2	NS630b/1600	N	380/415	50
	NS630b/1600	H	380/415	70

Unit price (incl.VAT) in VND

Compact NS >630A, Type N & H, 3P, 4P, Drawout type, Micrologic 2.0, Manual operated

Icu (415VAC)	Rating In(A)	Reference	3P Unit Price	Reference	4P Unit Price
50kA, Type N	630b	NS06bN3DM2	108,584,300	NS06bN4DM2	149,552,700
	800	NS080N3DM2	108,949,500	NS080N4DM2	159,088,600
	1000	NS100N3DM2	122,225,400	NS100N4DM2	171,461,400
	1250	NS125N3DM2	143,558,800	NS125N4DM2	199,405,800
	1600	NS160N3DM2	219,354,300	NS160N4DM2	239,825,300
70kA, Type H	630b	NS06bH3DM2	112,910,600	NS06bH4DM2	159,629,800
	800	NS080H3DM2	118,420,500	NS080H4DM2	165,433,400
	1000	NS100H3DM2	141,871,400	NS100H4DM2	176,765,600
	1250	NS125H3DM2	161,716,500	NS125H4DM2	205,448,100
	1600	NS160H3DM2	245,324,200	NS160H4DM2	279,937,900

Compact NS >630A, Type N & H, 3P, 4P, Drawout type, Micrologic 2.0, Electrical operated and Motor mechanism + MX + XF

Icu (415VAC)	Rating In(A)	Reference	3P Unit Price	Reference	4P Unit Price
50kA, Type N	630b	NS06bN3DE2	165,379,500	NS06bN4DE2	204,546,100
	800	NS080N3DE2	170,792,600	NS080N4DE2	210,079,100
	1000	NS100N3DE2	179,019,500	NS100N4DE2	215,855,200
	1250	NS125N3DE2	210,461,900	NS125N4DE2	245,901,700
	1600	NS160N3DE2	243,722,600	NS160N4DE2	283,210,400
70kA, Type H	630b	NS06bH3DE2	172,207,200	NS06bH4DE2	220,386,100
	800	NS080H3DE2	175,833,900	NS080H4DE2	221,056,000
	1000	NS100H3DE2	185,244,400	NS100H4DE2	226,650,600
	1250	NS125H3DE2	216,484,400	NS125H4DE2	262,198,200
	1600	NS160H3DE2	256,391,300	NS160H4DE2	302,941,100

Compact NS electrical auxiliaries and accessories - Rotary handle, locking and interlocking

Electrical auxiliaries for NS630b/3200A fixed type					
Auxiliary switch (changeover)		OF, SD, or SDE or SDV		29450	765,600
Shun trip (MX)	AC 50/60Hz	48		33660	8,113,600
		200/240		33662	8,113,600
		380/440		33664	8,113,600
		DC		33659	8,113,600
Under voltage (MN)	AC 50/60Hz	48		33660	8,113,600
		200/240		33671	8,113,600
		380/440		33673	8,113,600
		DC		33668	8,113,600
	Time day	220/240 VAC		33682	8,113,600

Rotary handle, locking, interlocking for NS630b/1600 (manually operation)

Rotary handle	Direct rotary handle		33863	3,839,000
	Extended rotary handles		33878	7,332,600
Mechanical interlock for 2 breakers (with extended rotary handles)			33890	5,768,400
Toggle locking device for 3 padlocks (removable)			44936	525,800

Accessories for NS630b/1600 fixed type

Connection adapter	Vertical	3P		33642	13,658,700
		4P		33643	17,361,300
	cable lug	3P		33644	12,177,000
		4P		33645	16,137,000
Spreader		3P (set of 3)		33622	7,739,600
		4P (set of 4)		33623	7,904,600
Interphase barrier		set of 3		33646	589,600
Additional extension toggle				33195	331,100

For accessories of Compact NS plug-in/drawout type, please consult us

Vui lòng liên hệ với chúng tôi nếu có nhu cầu về phụ kiện cơ khí và điện của Compact NS loại plug-in/ drawout



Pushbutton/Switches
/Pilot lights



Control Station



Control

TowerLights



Beacon



Sound

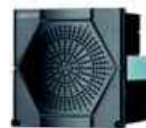

Signaling

Electronic Relays



Electromechanical Relays



Solid State Relays



Relay

Plastic IP65 protected monolithic pushbuttons, switches and pilot lights.

Economic design with wide range of color available. Reliable with key protected and long life bulbs.







Nút nhấn, đèn báo, công tắc xoay loại XB 7. Bảo vệ theo cấp IP 65.

Đầy sản phẩm kinh tế, với nhiều màu sắc đa dạng. Tuổi thọ cao.







Unit price (incl.VAT) in VND

Pilot lights Ø 22 with plastic bezel - Monolithic

Integral LED



	Supply Voltage		24 V AC/DC			230 V AC		
	Colour		Reference	Lot size	Unit Price	Reference	Lot size	Unit Price
	Green		XB7EV03BP	10	99,000	XB7EV03MP	10	99,000
	Red		XB7EV04BP	10	99,000	XB7EV04MP	10	99,000
	Yellow		XB7EV05BP	10	99,000	XB7EV05MP	10	99,000
	Blue		XB7EV06BP	10	99,000	XB7EV06MP	10	99,000
	Orange		XB7EV08BP	10	99,000	XB7EV08MP	10	99,000

Incandescent bulb

	Supply Voltage		6 or 24 V DC, or 130 V AC direct supply (bulb not included)			230 V AC direct through resistor (bulb included)		
	Colour		References	Lot size	Unit Price	Reference	Lot size	Unit Price
	Green		XB7EV63P	10	66,000	XB7EV73P	10	114,400
	Red		XB7EV64P	10	66,000	XB7EV74P	10	114,400
	Yellow		XB7EV65P	10	66,000	XB7EV75P	10	114,400
	Blue		XB7EV66P	10	66,000	XB7EV76P	10	114,400
	Clear		XB7EV67P	10	66,000	XB7EV77P	10	114,400

Illuminated pushbuttons Ø 22 with plastic bezel - Monolithic

Integral LED

	Supply Voltage		Spring return 230 V AC			Push and push-to-release 230 V AC		
	Colour	Type of Contacts	Reference	Lot size	Unit Price	Reference	Lot size	Unit Price
 	Green	N/O	XB7NW33M1	10	236,500	XB7NJ03M1	10	248,600
	Red	N/O	XB7NW34M1	10	236,500	XB7NJ04M1	10	248,600
		N/C	XB7NW34M2	10	236,500	XB7NJ04M2	10	249,700
	Blue	N/O	XB7NW36M1	10	236,500	XB7NJ06M1	10	248,600

Xb7 Accessories Ø 22 with plastic bezel - Monolithic

Incandescent bulbs, long life

BA 9s base fitting, Ø 11 mm max, length 28 max			
Voltage/ Power	Reference	Lot size	Unit Price
6 V (1.2 W)	DL1CB006	10	44,000
24 V (2 W)	DL1CE024	10	44,000
130 V (2.4 W)	DL1CE130	10	44,000



DL1CB006



ZBY2101



ZB5AZ905

Legend Plate, Key for tightening fixing nut

Voltage/ Power	Reference	Lot size	Unit Price
Blank Legend Plate	ZBY2101	10	42,900
Key for Tightening fixing nut	ZB5AZ905	10	125,400

Push Button & Selector switches

XB7 Ø 22 with plastic bezel - Monolithic

Plastic IP65 protected monolithic pushbuttons, switches and pilot lights.
Economic design with wide range of color available.
Reliable with key protected and long life bulbs.

Nút nhấn, đèn báo, công tắc xoay loại XB 7. Bảo vệ theo cấp IP 65.
Dãy sản phẩm kinh tế, với nhiều màu sắc đa dạng.
Tuổi thọ cao.

Unit price (incl.VAT) in VND

Push Button			Ø 22 with plastic bezel - Monolithic					
Type of Push			Flush, spring return			Flush, push and push-to-release		
	Colour	Type of Contacts	Reference	Lot size	Unit Price	Reference	Lot size	Unit Price
	Black ●	N/O	XB7NA21	10	70,400	XB7NH21	10	117,700
		C/O	XB7NA25	10	104,500	XB7NH25	10	140,800
	Green ●	N/O	XB7NA31	10	70,400	XB7NH31	10	117,700
		C/O	XB7NA35	10	104,500	XB7NH35	10	140,800
	Red ●	N/C	XB7NA42	10	70,400			
		C/O	XB7NA45	10	104,500			
Yellow ●	N/O	XB7NA81	10	70,400				

Selector switches			Ø 22 with plastic bezel - Monolithic					
Type of operator			Black handle 2 Positions Stay put ✓			Black handle 3 Positions Stay put ▼		
	Colour	Type of Contacts	Reference	Lot size	Unit Price	Reference	Lot size	Unit Price
	Black ●	N/O	XB7ND21	10	125,400	-		
		N/C + N/O	XB7ND25	10	134,200	-		
		2 N/O	-					
						XB7ND33	10	134,200

Key switches			Ø 22 with plastic bezel - Monolithic					
Type of operator			Ronis key, n° 455 2 Positions Stay put ▼			Ronis key, n° 455 3 Positions Stay put ▼		
	Colour	Type of Contacts	Reference	Lot size	Unit Price	Reference	Lot size	Unit Price
	Black ●	N/O	XB7NG21	10	185,900	-		
		2 N/O	-					
							XB7NG33	10

Ø 40 mushroom head pushbuttons IP54			Ø 22 with plastic bezel - Monolithic						
Type of operator			Turn to release			Key release, Ronis 455			
	Colour	Type of Contacts	Reference	Lot size	Unit Price	Reference	Lot size	Unit Price	
	Red ●	N/C	XB7NS8442	10	156,200	-			
		N/O + N/C	XB7NS8445	10	168,300	-			
		2N/C	-				XB7NS9444	10	310,200
		N/O + N/C	-				XB7NS9445	10	334,400



Plastic IP66 protected pushbuttons, switches and pilot lights.
Flexible adaptation design with wide range of color available.
Reliable with key protected and long life bulbs.

Bảo vệ theo cấp IP66
Thiết kế linh hoạt, cho phép nhiều sự phối hợp giữa thân và đầu của nút nhấn, đèn báo, công tắc xoay.
Tuổi thọ cao.

Unit price (incl.VAT) in VND



Pushbuttons, spring return

Flush

		Complete 		For user assembly 		For user assembly 	
Colour	Type of Contacts	Reference	Unit Price	Reference	Unit Price	Reference	Unit Price
Black ●	N/O	XB5AA21	140,800	ZB5AZ101	137,500	ZB5AA2	85,800
Green ●	N/O	XB5AA31	140,800	ZB5AZ101	137,500	ZB5AA3	85,800
Red ●	N/C	XB5AA42	140,800	ZB5AZ102	137,500	ZB5AA4	85,800
Yellow ●	N/O	XB5AA51	140,800	ZB5AZ101	137,500	ZB5AA5	85,800
Blue ●	N/O	XB5AA61	140,800	ZB5AZ101	137,500	ZB5AA6	85,800

Flush push, spring return, illuminated pushbuttons

illuminated pushbuttons with integral LED - Screw clamp terminals

		Complete 		For user assembly 		For user assembly 		
Supply voltage (V)	Colour	Type of Contacts	Reference	Unit Price	Reference	Unit Price	Reference	Unit Price
24V AC/DC Protected LED	White ○	N/O + N/C	XB5AW31B5	455,400	ZB5AW0B15	469,700	ZB5AW313	232,100
	Green ●	N/O + N/C	XB5AW33B5	455,400	ZB5AW0B35	469,700	ZB5AW333	232,100
	Red ●	N/O + N/C	XB5AW34B5	455,400	ZB5AW0B45	469,700	ZB5AW343	232,100
	Yellow ●	N/O + N/C	XB5AW35B5	455,400	ZB5AW0B55	469,700	ZB5AW353	232,100
	Blue ●	N/O + N/C	XB5AW36B5	455,400	ZB5AW0B65	469,700	ZB5AW363	232,100
48...120V AC Protected LED	White ○	N/O + N/C	XB5AW31G5	498,300	ZB5AW0G15	532,400	ZB5AW313	232,100
	Green ●	N/O + N/C	XB5AW33G5	498,300	ZB5AW0G35	532,400	ZB5AW333	232,100
	Red ●	N/O + N/C	XB5AW34G5	498,300	ZB5AW0G45	532,400	ZB5AW343	232,100
	Yellow ●	N/O + N/C	XB5AW35G5	498,300	ZB5AW0G55	532,400	ZB5AW353	232,100
	Blue ●	N/O + N/C	XB5AW36G5	498,300	ZB5AW0G65	532,400	ZB5AW363	232,100
230...240V AC Protected LED	White ○	N/O + N/C	XB5AW31M5	619,300	ZB5AW0M15	720,500	ZB5AW313	232,100
	Green ●	N/O + N/C	XB5AW33M5	619,300	ZB5AW0M35	720,500	ZB5AW333	232,100
	Red ●	N/O + N/C	XB5AW34M5	619,300	ZB5AW0M45	720,500	ZB5AW343	232,100
	Yellow ●	N/O + N/C	XB5AW35M5	619,300	ZB5AW0M55	720,500	ZB5AW353	232,100
	Blue ●	N/O + N/C	XB5AW36M5	619,300	ZB5AW0M65	720,500	ZB5AW363	232,100

illuminated pushbuttons with Direct supply for BA 9s bulb (not included) -Screw clamp terminals

		Complete 		For user assembly 		For user assembly 		
Supply voltage (V)	Colour	Type of Contacts	Reference	Unit Price	Reference	Unit Price	Reference	Unit Price
250 V max., 2.4 W max.	White ○	N/O + N/C	XB5AW3165	499,400	ZB5AW065	473,000	ZB5AW31	232,100
	Green ●	N/O + N/C	XB5AW3365	499,400	ZB5AW065	473,000	ZB5AW33	232,100
	Red ●	N/O + N/C	XB5AW3465	499,400	ZB5AW065	473,000	ZB5AW34	232,100
	Yellow ●	N/O + N/C	XB5AW3565	499,400	ZB5AW065	473,000	ZB5AW35	232,100

Ø 40 mm mushroom head Emergency stop pushbuttons

		Complete 		For user assembly 		For user assembly 		
Type of operator	Colour	Type of Contacts	Reference	Unit Price	Reference	Unit Price	Reference	Unit Price
Push-pull	●	N/C	XB5AT842	361,900	ZB5AZ102	137,500	ZB5AT84	310,200
Turn to release	●	N/C	XB5AS8442	355,300	ZB5AZ102	137,500	ZB5AS844	303,600
Key release	●	N/C	XB5AS9442	539,000	ZB5AZ102	137,500	ZB5AS944	523,600

Spare part and accessories







Description	Type of contacts	Reference	Unit Price
Single contact block	NO	ZBE101	70,400
Single contact block	NC	ZBE102	70,400









Note: Maximum recommended for additional contact block from 4 to 9

Plastic IP66 protected pushbuttons, switches and pilot lights.
Flexible adaptation design with wide range of color available.
Reliable with key protected and long life bulbs.

Bảo vệ theo cấp IP66
Thiết kế linh hoạt, cho phép nhiều sự phối hợp giữa thân và đầu của nút nhấn, đèn báo, công tắc xoay.
Tuổi thọ cao.

Unit price (incl.VAT) in VND

Pilot lights			Ø 22 with metal bezel - Modular					
			Pilot lights with integral LED - Screw clamp terminals					
			Complete 		For user assembly 		For user assembly 	
Supply voltage (V)	Colour		Reference	Unit Price	Reference	Unit Price	Reference	Unit Price
24 V AC/DC	White	○	XB5AVB1	260,700	ZB5AVB1	258,500	ZB5AV013	81,400
	Green	●	XB5AVB3	260,700	ZB5AVB3	258,500	ZB5AV033	81,400
	Red	●	XB5AVB4	260,700	ZB5AVB4	258,500	ZB5AV043	81,400
	Yellow orange	●	XB5AVB5	260,700	ZB5AVB5	258,500	ZB5AV053	81,400
	Blue	●	XB5AVB6	260,700	ZB5AVB6	258,500	ZB5AV063	81,400
	48...120 V AC	White	○	XB5AVG1	287,100	ZB5AVG1	290,400	ZB5AV013
Green		●	XB5AVG3	287,100	ZB5AVG3	290,400	ZB5AV033	81,400
Red		●	XB5AVG4	287,100	ZB5AVG4	290,400	ZB5AV043	81,400
Yellow orange		●	XB5AVG5	287,100	ZB5AVG5	290,400	ZB5AV053	81,400
Blue		●	XB5AVG6	287,100	ZB5AVG6	290,400	ZB5AV063	81,400
230...240 V AC		White	○	XB5AVM1	315,700	ZB5AVM1	328,900	ZB5AV013
	Green	●	XB5AVM3	315,700	ZB5AVM3	328,900	ZB5AV033	81,400
	Red	●	XB5AVM4	315,700	ZB5AVM4	328,900	ZB5AV043	81,400
	Yellow orange	●	XB5AVM5	315,700	ZB5AVM5	328,900	ZB5AV053	81,400
	Blue	●	XB5AVM6	315,700	ZB5AVM6	328,900	ZB5AV063	81,400
				Pilot lights with Direct supply for BA 9s bulb (not included) - Screw clamp terminals				
			Complete 		For user assembly 		For user assembly 	
Supply voltage (V)	Colour		Reference	Unit Price	Reference	Unit Price	Reference	Unit Price
250 V max., 2.4 W max.	White	○	XB5AV61	181,500	ZB5AV6	125,400	ZB5AV01	81,400
	Green	●	XB5AV63	181,500	ZB5AV6	125,400	ZB5AV03	81,400
	Red	●	XB5AV64	181,500	ZB5AV6	125,400	ZB5AV04	81,400
	Yellow orange	●	XB5AV65	182,600	ZB5AV6	125,400	ZB5AV05	81,400

Selector switches and key switches				Ø 22 with metal bezel - Modular					
				Standard handle Black					
				Complete 		For user assembly 		For user assembly 	
Colour	Number and type of positions	Type of Contacts		Reference	Unit Price	Reference	Unit Price	Reference	Unit Price
●	2 positions stay put	∨	N/O	XB5AD21	243,100	ZB5AZ101	137,500	ZB5AD2	163,900
	2 positions stay put	∨	N/O + N/C	XB5AD25	271,700	ZB5AZ105	173,800	ZB5AD2	163,900
	3 positions stay put	∨	2 N/O	XB5AD33	277,200	ZB5AZ103	173,800	ZB5AD3	173,800
	3 positions spring return to centre	∨	2 N/O	XB5AD53	326,700	ZB5AZ103	173,800	ZB5AD5	237,600
				Long handle Black					
				Complete 		For user assembly 		For user assembly 	
Colour	Number and type of positions	Type of Contacts		Reference	Unit Price	Reference	Unit Price	Reference	Unit Price
●	2 positions stay put	∨	N/O	XB5AJ21	322,300	ZB5AZ101	137,500	ZB5AJ2	260,700
	3 positions stay put	∨	2 N/O	XB5AJ33	349,800	ZB5AZ103	173,800	ZB5AJ3	265,100
	3 positions spring return to centre	∨	2 N/O	XB5AJ53	412,500	ZB5AZ103	173,800	ZB5AJ5	345,400
				Key, n° 455					
				Complete 		For user assembly 		For user assembly 	
Colour	Number and type of positions	Type of Contacts		Reference	Unit Price	Reference	Unit Price	Reference	Unit Price
●	2 positions stay put	Left	N/O	XB5AG21	515,900	ZB5AZ101	137,500	ZB5AG2	502,700
	2 positions stay put	All	N/O	XB5AG41	541,200	ZB5AZ101	137,500	ZB5AG4	532,400
	2 positions spring return	Left	N/O	XB5AG61	552,200	ZB5AZ101	137,500	ZB5AG6	547,800
	3 positions spring return to centre	All	2 N/O	XB5AG03	570,900	ZB5AZ103	173,800	ZB5AG0	540,100
	3 positions spring return to centre	Middle	2 N/O	XB5AG33	596,200	ZB5AZ103	173,800	ZB5AG3	572,000

Metallic IP66 protected pushbuttons, switches and pilot lights
Flexible adaptation design with wide range of color available
Reliable with key protected and long life bulbs

Chế tạo từ vật liệu kim loại, IP66
Thiết kế linh hoạt, cho phép nhiều sự phối hợp giữa thân và đầu của nút nhấn, đèn báo, công tắc xoay.
Tuổi thọ cao, phù hợp cho ứng dụng ở môi trường bụi bặm, ô nhiễm.

Unit price (incl.VAT) in VND

Pushbuttons, spring return			Ø 22 with metal bezel - Modular					
			Flush					
			Complete		For user assembly		For user assembly	
Type of Push	Colour	Type of Contacts	Reference	Unit Price	Reference	Unit Price	Reference	Unit Price
Flush	Black ●	N/O	XB4BA21	248,600	ZB4BZ101	159,500	ZB4BA2	176,000
	Green ●	N/O	XB4BA31	248,600	ZB4BZ101	159,500	ZB4BA3	176,000
	Red ●	N/C	XB4BA42	248,600	ZB4BZ102	159,500	ZB4BA4	176,000
	Yellow ●	N/O	XB4BA51	248,600	ZB4BZ101	159,500	ZB4BA5	176,000
	Blue ●	N/O	XB4BA61	248,600	ZB4BZ101	159,500	ZB4BA6	176,000
Flush with clear silicone boot								
			Complete		For user assembly		For user assembly	
Type of Push	Colour	Type of Contacts	Reference	Unit Price	Reference	Unit Price	Reference	Unit Price
Flush with clear silicone boot	Black ●	N/O	XB4BP21	427,900	ZB4BZ101	159,500	ZB4BP2	325,600
	Green ●	N/O	XB4BP31	427,900	ZB4BZ101	159,500	ZB4BP3	325,600
	Red ●	N/C	XB4BP42	427,900	ZB4BZ102	159,500	ZB4BP4	325,600
	Yellow ●	N/O	XB4BP51	427,900	ZB4BZ101	159,500	ZB4BP5	325,600
	Blue ●	N/O	XB4BP61	427,900	ZB4BZ101	159,500	ZB4BP6	325,600
Projecting								
			Complete		For user assembly		For user assembly	
Type of Push	Colour	Type of Contacts	Reference	Unit Price	Reference	Unit Price	Reference	Unit Price
Projecting	Red ●	N/C	XB4BL42	368,500	ZB4BZ102	159,500	ZB4BL4	247,500
Mushroom head, Ø 40 mm								
			Complete		For user assembly		For user assembly	
Type of Push	Colour	Type of Contacts	Reference	Unit Price	Reference	Unit Price	Reference	Unit Price
Mushroom head, Ø 40 mm	Black ●	N/O	XB4BC21	499,400	ZB4BZ101	159,500	ZB4BC2	431,200
Double-headed pushbuttons IP 66 - IP 69K								
			Complete		For user assembly		For user assembly	
Type of Push	Colour	Type of Contacts	Reference	Unit Price	Reference	Unit Price	Reference	Unit Price
Double-headed pushbuttons	Black ●	N/O	XB4BL73415	770,000	ZB4BZ105	200,200	ZB4BL7341	710,600
Ø 40 mm mushroom head Emergency stop pushbuttons			Ø 22 with metal bezel - Modular					
			Complete		For user assembly		For user assembly	
Type of operator	Colour	Type of Contacts	Reference	Unit Price	Reference	Unit Price	Reference	Unit Price
Push-pull	●	N/C	XB4BT842	623,700	ZB4BZ102	159,500	ZB4BT84	601,700
Turn to release	●	N/C	XB4BS8442	617,100	ZB4BZ102	159,500	ZB4BS844	592,900
Key release	●	N/O+N/C	XB4BS9445	591,800	ZB4BZ105	200,200	ZB4BS944	960,300
Spare part and accessories								
Description			Type of contacts				Reference	Unit Price
Single contact block			NO				ZBE101	70,400
Single contact block			NC				ZBE102	70,400

Note: Maximum recommended for additional contact block from 4 to 9







**Flush push, spring return,
illuminated pushbuttons**

XB4 Ø 22 with metal bezel - Modular

Metallic IP66 protected pushbuttons, switches and pilot lights
Flexible adaptation design with wide range of color available
Reliable with key protected and long life bulbs

Chế tạo từ vật liệu kim loại, IP66
Thiết kế linh hoạt, cho phép nhiều sự phối hợp giữa thân và đầu của nút nhấn, đèn báo, công tắc xoay.
Tuổi thọ cao, phù hợp cho ứng dụng ở môi trường bụi bặm, ô nhiễm.









Unit price (incl.VAT) in VND







Flush push, spring return, illuminated pushbuttons			Ø 22 with metal bezel - Modular					
			illuminated pushbuttons with integral LED - Screw clamp terminals					
			Complete 		For user assembly 		For user assembly 	
Supply voltage (V)	Colour	Type of Contacts	Reference	Unit Price	Reference	Unit Price	Reference	Unit Price
24 V AC/DC Protected[®] LED	White ○	N/O + N/C	XB4BW31B5	629,200	ZB4BW0B15	520,300	ZB4BW313	361,900
	Green ●	N/O + N/C	XB4BW33B5	629,200	ZB4BW0B35	520,300	ZB4BW333	361,900
	Red ●	N/O + N/C	XB4BW34B5	629,200	ZB4BW0B45	520,300	ZB4BW343	361,900
	Yellow ●	N/O + N/C	XB4BW35B5	629,200	ZB4BW0B55	520,300	ZB4BW353	361,900
	Blue ●	N/O + N/C	XB4BW36B5	629,200	ZB4BW0B65	520,300	ZB4BW363	361,900
48...120 V AC Protected[®] LED	White ○	N/O + N/C	XB4BW31G5	687,500	ZB4BW0G15	594,000	ZB4BW313	361,900
	Green ●	N/O + N/C	XB4BW33G5	687,500	ZB4BW0G35	594,000	ZB4BW333	361,900
	Red ●	N/O + N/C	XB4BW34G5	687,500	ZB4BW0G45	594,000	ZB4BW343	361,900
	Yellow ●	N/O + N/C	XB4BW35G5	686,400	ZB4BW0G55	594,000	ZB4BW353	361,900
	Blue ●	N/O + N/C	XB4BW36G5	686,400	ZB4BW0G65	594,000	ZB4BW363	361,900
230...240 V AC Protected[®] LED	White ○	N/O + N/C	XB4BW31M5	855,800	ZB4BW0M15	801,900	ZB4BW313	361,900
	Green ●	N/O + N/C	XB4BW33M5	856,900	ZB4BW0M35	801,900	ZB4BW333	361,900
	Red ●	N/O + N/C	XB4BW34M5	856,900	ZB4BW0M45	801,900	ZB4BW343	361,900
	Yellow ●	N/O + N/C	XB4BW35M5	855,800	ZB4BW0M55	801,900	ZB4BW353	361,900
	Blue ●	N/O + N/C	XB4BW36M5	855,800	ZB4BW0M65	801,900	ZB4BW363	361,900
			illuminated pushbuttons with Direct supply for BA 9s bulb (not included) - Screw clamp terminals					
			Complete 		For user assembly 		For user assembly 	
Supply voltage (V)	Colour	Type of Contacts	Reference	Unit Price	Reference	Unit Price	Reference	Unit Price
250 V max., 2.4 W max.	White ○	N/O + N/C	XB4BW3165	546,700	ZB4BW065	473,000	ZB4BW31	232,100
	Green ●	N/O + N/C	XB4BW3365	546,700	ZB4BW065	473,000	ZB4BW33	232,100
	Red ●	N/O + N/C	XB4BW3465	546,700	ZB4BW065	473,000	ZB4BW34	232,100
	Yellow ●	N/O + N/C	XB4BW3565	546,700	ZB4BW065	473,000	ZB4BW35	232,100

Metallic IP66 protected pushbuttons, switches and pilot lights
Flexible adaptation design with wide range of color available
Reliable with key protected and long life bulbs

Chế tạo từ vật liệu kim loại, IP66
Thiết kế linh hoạt, cho phép nhiều sự phối hợp giữa thân và đầu của nút nhấn, đèn báo, công tắc xoay.
Tuổi thọ cao, phù hợp cho ứng dụng ở môi trường bụi bặm, ô nhiễm.

Unit price (incl.VAT) in VND

Selector switches and key switches			Ø 22 with metal bezel - Modular					
			Standard handle Black					
			Complete 		For user assembly 		For user assembly 	
Colour	Number and type of positions	Type of Contacts	Reference	Unit Price	Reference	Unit Price	Reference	Unit Price
●	2 positions stay put	∨ N/O	XB4BD21	279,400	ZB4BZ101	159,500	ZB4BD2	188,100
	2 positions stay put	∨ N/O + N/C	XB4BD25	315,700	ZB4BZ105	200,200	ZB4BD2	188,100
	3 positions stay put	∨ 2 N/O	XB4BD33	322,300	ZB4BZ103	200,200	ZB4BD3	201,300
	3 positions spring return to centre	∨ 2 N/O	XB4BD53	377,300	ZB4BZ103	200,200	ZB4BD5	271,700
			Long handle Black					
			Complete 		For user assembly 		For user assembly 	
Colour	Number and type of positions	Type of Contacts	Reference	Unit Price	Reference	Unit Price	Reference	Unit Price
●	2 positions stay put	∨ N/O	XB4BJ21	372,900	ZB4BZ101	159,500	ZB4BJ2	299,200
	3 positions stay put	∨ 2 N/O	XB4BJ33	407,000	ZB4BZ103	200,200	ZB4BJ3	304,700
	3 positions spring return to centre	∨ 2 N/O	XB4BJ53	479,600	ZB4BZ103	200,200	ZB4BJ5	394,900
			Key, n° 455					
			Complete 		For user assembly 		For user assembly 	
Colour	Number and type of positions	Type of Contacts	Reference	Unit Price	Reference	Unit Price	Reference	Unit Price
●	2 positions stay put	Left N/O	XB4BG21	598,400	ZB4BZ101	159,500	ZB4BG2	575,300
	2 positio	All N/O	XB4BG41	628,100	ZB4BZ101	159,500	ZB4BG4	613,800
	2 positions spring return	Left N/O	XB4BG61	642,400	ZB4BZ101	159,500	ZB4BG6	629,200
	3 positions spring return to center	All 2 N/O	XB4BG03	663,300	ZB4BZ103	200,200	ZB4BG0	621,500
	3 positions spring return to center	Center 2 N/O	XB4BG33	691,900	ZB4BZ103	200,200	ZB4BG3	657,800

Pilot lights			Ø 22 with metal bezel - Modular					
			Pilot lights with integral LED - Screw clamp terminals					
			Complete 		For user assembly 		For user assembly 	
Supply voltage (V)	Colour		Reference	Unit Price	Reference	Unit Price	Reference	Unit Price
24 V AC/DC Protected LED	White	○	XB4BVB1	416,900	ZB4BVB1	413,600	ZB4BV013	250,800
	Green	●	XB4BVB3	416,900	ZB4BVB3	413,600	ZB4BV033	250,800
	Red	●	XB4BVB4	416,900	ZB4BVB4	413,600	ZB4BV043	250,800
	Yellow orange	●	XB4BVB5	416,900	ZB4BVB5	413,600	ZB4BV053	250,800
	Blue	●	XB4BVB6	416,900	ZB4BVB6	413,600	ZB4BV063	250,800
	48...120 V AC Protected LED	White	○	XB4BVG1	540,100	ZB4BVG1	468,600	ZB4BV013
Green		●	XB4BVG3	540,100	ZB4BVG3	468,600	ZB4BV033	250,800
Red		●	XB4BVG4	540,100	ZB4BVG4	468,600	ZB4BV043	250,800
Yellow orange		●	XB4BVG5	540,100	ZB4BVG5	468,600	ZB4BV053	250,800
Blue		●	XB4BVG6	540,100	ZB4BVG6	468,600	ZB4BV063	250,800
230...240 V AC Protected LED		White	○	XB4BVM1	690,800	ZB4BVM1	721,600	ZB4BV013
	Green	●	XB4BVM3	690,800	ZB4BVM3	721,600	ZB4BV033	250,800
	Red	●	XB4BVM4	690,800	ZB4BVM4	721,600	ZB4BV043	250,800
	Yellow orange	●	XB4BVM5	690,800	ZB4BVM5	721,600	ZB4BV053	250,800
	Blue	●	XB4BVM6	690,800	ZB4BVM6	721,600	ZB4BV063	250,800
				Pilot lights with Direct supply for BA 9s bulb (not included) - Screw clamp terminals				
			Complete 		For user assembly 		For user assembly 	
Supply voltage (V)	Colour		Reference	Unit Price	Reference	Unit Price	Reference	Unit Price
250 V max., 2.4 W max.	White	○	XB4BV61	418,000	ZB4BV6	289,300	ZB4BV01	267,300
	Green	●	XB4BV63	418,000	ZB4BV6	289,300	ZB4BV03	267,300
	Red	●	XB4BV64	418,000	ZB4BV6	289,300	ZB4BV04	267,300
	Yellow orange	●	XB4BV65	418,000	ZB4BV6	289,300	ZB4BV05	267,300

Front mounting, "multi fixing" or by Ø 22mm
 Flexible addaptation design with wide range of color available
 Reliable with key protected and long life bulbs

Chế tạo từ vật liệu kim loại
 Thiết kế linh hoạt, cho phép nhiều sự phối hợp giữa thân và đầu của nút nhấn, đèn báo, công tắc xoay.
 Tuổi thọ cao, phù hợp cho môi trường hóa chất, ô nhiễm

Unit price (incl.VAT) in VND

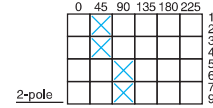
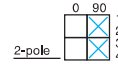
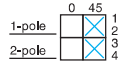

Cam switches, K1 / K2 series							
Rated insulation voltage (Ui) conforming to IEC60947-1 : 690V							
Nbr of position / Nbr of pole		2 / 2		2 / 2		2 + "0" position / 2	
Front mounting method		Switches 45° switching angle		ON-OFF switches 90° switching angle		Stepping switches with "0" position	
Multifixing plate, 45 x 45 mm		Reference	Unit Price	Reference	Unit Price	Reference	Unit Price
Plastic mounting plate for Ø 22 mm hole		K1B002ALH	595,100	K1B1002HLH	914,100	K1D012QLH	1,147,300
		K1B002ACH	1,112,100	K1B1002HCH	1,113,200	K1D012QCH	1,229,800

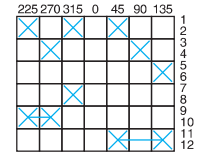
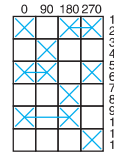
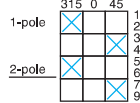



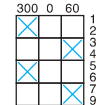
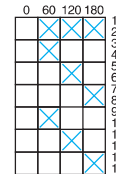
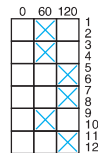

Cam switches, K1 / K2 series							
Rated insulation voltage (Ui) conforming to IEC60947-1 : 690V							
Nbr of position / Nbr of pole		2 + "0" position / 2		3 + "0" position / 4		6 + "0" position / 7	
Front mounting method		Changeover switches		Ammeter switches		Voltmeter switches	
Multifixing plate, 45 x 45 mm		Reference	Unit Price	Reference	Unit Price	Reference	Unit Price
Plastic mounting plate for Ø 22 mm hole		K1D002ULH	1,111,000	K1F003MLH	1,521,300	K1F027MLH	1,465,200
		K1D002UCH	1,316,700	K1F003MCH	1,696,200	K1F027MCH	1,659,900



Cam switches with key operated lock, K1 series							
Rated insulation voltage (Ui) conforming to IEC60947-1 : 690V							
Nbr of position / Nbr of pole		2 + "0" position / 3		3 + "0" position / 2		2 + "0" position / 2	
Colour		Stepping switches		Run switches		Changeover switches + "0" pos	
Front mounting method		Reference	Unit Price	Reference	Unit Price	Reference	Unit Price
●	Ø 22 mm hole + Ø 43.5 mm hole	K1F022QZ2	5,452,700	K1G043RZ2	5,815,700	K1D002UZ2	5,450,500
●	Ø 22 mm hole + Ø 43.5 mm hole	K1F022QZ4	5,487,900	K1G043RZ4	5,813,500	K1D002UZ4	5,447,200

Control stations - Harmony XAL

Unit price (incl.VAT) in VND



Complete stations with 1 pushbutton, selector switch or key switch						
1 Start or Stop function						
	Contact	Marking	Reference	Unit Price	Reference	Unit Price
	N/O	I	XALD102	515,900	-	
	N/C	O			XALD112	543,400
1 Start-Stop function						
	Contact	Marking	Reference	Unit Price	Reference	Unit Price
	N/O	O-I	XALD134	555,500	XALD144	819,500
					Key n° 455 (key withdrawal LH pos.)	
Emergency stop (2) (light grey RAL 7035 base with yellow RAL 1012 lid)						
	Contact		Reference	Unit Price	Reference	Unit Price
	N/C + N/C		XALK178F	635,800	XALK188F	803,000
	N/C + N/O		XALK178E	635,800	XALK188E	803,000
	N/C + N/C + N/O		XALK178G	737,000	XALK188G	903,100
Start-Stop functions						
	Contact	Marking	Reference	Unit Price	Reference	Unit Price
	N/O + N/C	O-I	XALD213	1,076,900	XALD363M 230Vac	1,797,400
		Start- stop	XALD215	1,076,900	XALD363B 24VDC	1,797,400
					1 Flush green p/b1 Flush red p/b 1 Flush green p/b1 Flush red p/b 1 red pilot light with integral LED230 V AC	

Empty control stations

For XB7 range

 XALE02	Number of holes	Reference	Unit Price
		1	XALE1
	2	XALE2	229,900
	3	XALE3	242,000

For XB4/ XB5 range

 XALK01	 XALD02	Light grey RAL 7035 based Dark grey RAL 7016 lid		Light grey RAL 7035 based Yellow RAL 1021 lid	
		Reference	Unit Price	Reference	Unit Price

Control Stations & small joystick controllers



Pendant control stations, for control circuits

Double insulated intuitive operation, type XAC-A "Pistol grip" Complete stations "ready for use"



Hộp điều khiển hệ thống nâng hạ Cơ cấu vận hành an toàn, độ bền và độ cách điện cao Cung cấp dưới dạng hộp rỗng hoặc có lắp sẵn nút nhấn

Unit price (incl.VAT) in VND



For control of hoist motors

Single-speed hoist motors		Number of operators	Type of operators	Per direction	E. stop	Reference	Unit Price
	2 mechanically interlocked	Standard	1N/O	-	XACA201	2,196,700	
			1N/C + 1N/O	-	XACA205	2,409,000	
	2 mechanically interlocked	Booted	1N/O	-	XACA211	2,414,500	
			1N/C + 1N/O	-	XACA215	2,626,800	
	+ 1 trigger action latching Ø 30 mm E-Stop	Standard	1N/O	N/C	XACA2014	2,838,000	
			1N/C + 1N/O	N/C	XACA2054	3,128,400	
+ 1 trigger action latching Ø 30 mm E-Stop	Booted	1N/O	N/C	XACA2114	2,987,600		
		1N/C + 1N/O	N/C	XACA2154	3,246,100		
Two-speed hoist motors		Number of operators	Type of operators	Per direction	E. stop	Reference	Unit Price
	2 mechanically interlocked	Standard	2 steps,	-	XACA207	2,732,400	
			1N/O + 1N/O	-	XACA217	2,818,200	
	+ 1 trigger action latching Ø 30 mm E-Stop	Standard	staggered	N/C	XACA2074	3,412,200	
			Booted	N/C	XACA2174	3,649,800	

For control of motors

Single-speed motors		Number of operators	Per direction	E. stop	Reference	Unit Price
	2 mechanically interlocked	N/O	-	XACA271	1,476,200	
		N/C+N/O	-	XACA281	1,543,300	
	+ 1 trigger action latching Ø 30 mm E-Stop	N/O	N/C	XACA2714	2,667,500	
		N/C+N/O	N/C	XACA2814	2,798,400	
	4 mechanically interlocked	N/O	3 N/C	XACA27141	4,103,000	
N/C+N/O		3 N/C	XACA28141	4,202,000		
Two-speed motors		Number of operators	Per direction	E. stop	Reference	Unit Price
	4 mechanically interlocked	N/O	-	XACA491	3,476,000	
		N/C+N/O	N/C	XACA4914	3,876,400	
	+ 1 trigger action	N/O	3 N/C	XACA49141	4,917,000	

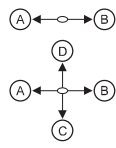
Joystick controller (with 54 mm long operating shaft) - complete products

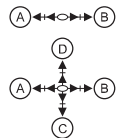
One contact per 1 direction - 1 speed		Operation	Sprint return to zero position	Contact per direction	Reference	Unit Price
		2-dreiction	Without	1 NO	XD5PA12	1,669,800
		2-dreiction	With	1 NO	XD5PA22	1,771,000
		4-dreiction	Without	1 NO	XD5PA14	2,957,900
		4-dreiction	With	1 NO	XD5PA24	3,027,200
Two contact per 1 direction - 2 speed		Number of operators	Sprint return to zero position	Contact per direction	Reference	Unit Price
		2-dreiction	Without	2 NO	XD2GA8241	4,680,500
		2-dreiction	With	2 NO	XD2GA8251	4,764,100
		4-dreiction	Without	2 NO	XD2GA8441	5,710,100
		4-dreiction	With	2 NO	XD2GA8451	5,877,300

LED Indicator bank Ø 60mm
 With 2, 3 or 4 illuminated signalling units,
 coloured LEDs and clear lenses
 Voltage: 24Vac/dc
 Multi mounting, specially of foldable bracket

Đèn tầng cảnh báo Ø 60mm
 Đèn 2,3,4 tầng, LED màu và ống nhựa bọc bên ngoài trong suốt
 Điện áp: 24Vac/dc
 Đế đèn đa dạng, đặc biệt có dạng để gập lại được

Unit price (incl.VAT) in VND

Compact tower light XVG Ø 60 mm, 24VAC/DC



With base mounting

Degree of protection	Buzzer	Signalling colors	Reference	Unit Price
IP53	No	Red, Green	XVGB2W	1,746,800
IP53	No	Red, Amber, Green	XVGB3W	2,096,600
IP53	No	Red, Amber, Green, Blue	XVGB4W	2,583,900
IP42	Yes	Red, Green	XVGB2SW	2,250,600
IP42	Yes	Red, Amber, Green	XVGB3SW	2,625,700
IP42	Yes	Red, Amber, Green, Blue	XVGB4SW	3,151,500

With direct aluminium tube mounting

Degree of protection	Buzzer	Signalling colors	Reference	Unit Price
IP23	No	Red, Green	XVGB2T	1,816,100
IP23	No	Red, Amber, Green	XVGB3T	2,167,000
IP23	No	Red, Amber, Green, Blue	XVGB4T	2,653,200
IP23	Yes	Red, Green	XVGB2ST	2,325,400
IP23	Yes	Red, Amber, Green	XVGB3ST	2,700,500
IP23	Yes	Red, Amber, Green, Blue	XVGB4ST	3,226,300

With aluminium tube mounting and L-bracket

Degree of protection	Buzzer	Signalling colors	Reference	Unit Price
IP23	No	Red, Green	XVGB2	1,885,400
IP23	No	Red, Amber, Green	XVGB3	2,234,100
IP23	No	Red, Amber, Green, Blue	XVGB4	2,723,600
IP23	Yes	Red, Green	XVGB2S	2,399,100
IP23	Yes	Red, Amber, Green	XVGB3S	2,774,200
IP23	Yes	Red, Amber, Green, Blue	XVGB4S	3,300,000

With aluminium tube mounting and fixing plate

Degree of protection	Buzzer	Signalling colors	Reference	Unit Price
IP53	No	Red, Green	XVGB2H	1,885,400
IP53	No	Red, Amber, Green	XVGB3H	2,234,100
IP53	No	Red, Amber, Green, Blue	XVGB4H	2,723,600
IP42	Yes	Red, Green	XVGB2SH	2,399,100
IP42	Yes	Red, Amber, Green	XVGB3SH	2,774,200
IP42	Yes	Red, Amber, Green, Blue	XVGB4SH	3,300,000

With aluminium tube mounting and foldable bracket

Degree of protection	Buzzer	Signalling colors	Reference	Unit Price
IP40	No	Red, Green	XVGB2M	2,167,000
IP40	No	Red, Amber, Green	XVGB3M	2,513,500
IP40	No	Red, Amber, Green, Blue	XVGB4M	3,001,900
IP40	Yes	Red, Green	XVGB2SM	2,701,600
IP40	Yes	Red, Amber, Green	XVGB3SM	3,075,600
IP40	Yes	Red, Amber, Green, Blue	XVGB4SM	3,599,200

Compact tower light XVG Ø60mm with USB port - multi color

Degree of protection	Buzzer	Signalling colors	Reference	Unit Price
With base mounting				
IP42	Yes	Multi-color Setting by Software	XVGU3SWV	3,099,800
With aluminium tube mounting and fixing plate				
IP42	Yes	Multi-color Setting by Software	XVGU3SHAV	3,503,500

Indicator bank Ø 45mm optimum
 Electric shock protection conforming to IEC 61140, IEC 60947-1 and IEC 60947-5-1
 Voltage consumption 24Vac/dc, 120Vac, 230Vac
 2-4 illuminated units & multi-choice flashing units

Đèn hiệu cảnh báo nhiều tầng Ø 45mm
 Bảo vệ chống giật theo tiêu chuẩn quốc tế: IEC 61140, IEC 60947-1 và IEC 60947-5-1
 Điện áp tiêu thụ: 24Vac/dc, 120Vac, 230Vac
 Từ 2-4 phần tử, có chỉ định phần tử cảnh báo.

Unit price (incl.VAT) in VND

Complete, pre-wired tower light XVM Ø 45 mm / IP42

	Light source (included) - Incandescent BA 15d bulb, 5 W max. with Buzzer					
	2 signalling units + integral buzzer Steady light		3 signalling units + integral buzzer Steady light		3 signalling units + integral buzzer Steady light + "Flash"	
Type of Contacts	Reference	Unit Price	Reference	Unit Price	Reference	Unit Price
24 V AC/DC	XVMB2RGSSB	2,046,000	XVMB2RAGSSB	2,293,500	XVMB2R6AGSSB	3,119,600
120 V AC/DC (bulb) - 120 V AC (LED)	XVMG2RGSSB	2,247,300	XVMG2RAGSSB	2,523,400	XVMG2R6AGSSB	3,433,100
230 V AC/DC (bulb) - 230 V AC (LED)	XVMM2RGSSB	2,360,600	XVMM2RAGSSB	2,649,900	XVMM2R6AGSSB	3,602,500



Breakdown of the reference for a pre-assembled indicator bank (1)

	XVM	1 units				2 units				3 units				4 units					
		B	G	M	1	2	R	A	G	B	C	R	A	G	B	C	(3)	S	
Voltage	≈ 24 V	B																	
	~ 120V	G																	
	~ 230 V	M																	
Light source	Incandescent bulb				1														
(2)	LED				2														
Illuminated unit	Red						R		R		R		R						
	Orange						A		A		A		A						
Colour	Green						G		G		G		G						
	Blue						B		B		B		B						
	Clear						C		C		C		C						
	Steady						(3)		(3)		(3)		(3)						
Signalling	Flashing						5		5		5		5						
	"Flash"						6		6		6		6						
Buzzer	Without																		(3)
	With																		S



- (1) This table is purely for information and must not be used to create a product reference.
- (2) "Flash" discharge tube to be ordered separately,
- (3) Not indicated, default value.

Complete, pre-wired tower lights, Steady light, Ø 40 mm / Up to IP54

	Light source (included) - LED - Without buzzer					
	Base mounting 24V AC/DC		Support tube mounting, 17 mm 24V AC/DC		Support tube mounting, 17 mm 100-240V AC	
Type of Contacts	Reference	Unit Price	Reference	Unit Price	Reference	Unit Price
Red ●	XVC4B1K	3,302,200	XVC4B1	3,744,400	XVC4M1	8,014,600
Orange/Red ●●	XVC4B2K	4,049,100	XVC4B2	4,492,400	XVC4M2	8,823,100
Green/Orange/Red ●●●	XVC4B3K	4,715,700	XVC4B3	5,168,900	XVC4M3	9,427,000
Blue/Green/Orange/Red ●●●●	XVC4B4K	5,991,700	XVC4B4	6,044,500	XVC4M4	10,274,000
Clear/Blue/Green/Orange/Red ○●●●●	XVC4B5K	6,490,000	XVC4B5	6,953,100	XVC4M5	11,150,700



Complete, pre-wired tower lights, Steady light, Ø 60 mm / Up to IP54

	Light source (included) - LED - Without buzzer					
	Base mounting 24V AC/DC		Support tube mounting, 22 mm 24V AC/DC		Support tube mounting, 22 mm 100-240V AC	
Type of Contacts	Reference	Unit Price	Reference	Unit Price	Reference	Unit Price
Red ●	XVC6B1K	4,009,500	XVC6B1	4,950,000	XVC6M1	8,993,600
Orange/Red ●●	XVC6B2K	5,162,300	XVC6B2	6,160,000	XVC6M2	9,995,700
Green/Orange/Red ●●●	XVC6B3K	6,297,500	XVC6B3	7,363,400	XVC6M3	10,958,200
Blue/Green/Orange/Red ●●●●	XVC6B4K	7,442,600	XVC6B4	8,570,100	XVC6M4	11,917,400
Clear/Blue/Green/Orange/Red ○●●●●	XVC6B5K	8,591,000	XVC6B5	9,762,500	XVC6M5	12,896,400



Standard RPM relay with current 15 A.

- Spring return test button for testing the contacts (standard)
- Green LED indication of relay status (depending on version)
- Mechanical indication of relay status (standard)
- Plug-in protection module to protect against electrical spikes

Refer to Catalog 8501CT0601

Relay RPM dòng điện 15 A

- Cờ báo trạng thái tiếp điểm (có sẵn)
- Nút ấn tự nhà để thử tiếp điểm (có sẵn)
- Đèn Led báo trạng thái của relay (theo loại)
- Các module bảo vệ sốc dòng điện

Unit price (incl.VAT) in VND

Power relays without LED (sold in lots of 10)

Coil Voltage	Number and type of contacts - Thermal current (Ith)							
	1 C/O - 15 A		2 C/O - 15 A		3 C/O - 15 A		4 C/O - 15 A	
	Reference	Unit Price	Reference	Unit Price	Reference	Unit Price	Reference	Unit Price
12 Vdc	RPM11JD	115,500	RPM21JD	162,800	RPM31JD	224,400	RPM41JD	260,700
24 Vdc	RPM11BD	115,500	RPM21BD	162,800	RPM31BD	224,400	RPM41BD	260,700
48 Vdc	RPM11ED	133,100	RPM21ED	193,600	RPM31ED	258,500	RPM41ED	260,700
110 Vdc	RPM11FD	133,100	RPM21FD	193,600	RPM31FD	258,500	RPM41FD	260,700
24 Vac	RPM11B7	123,200	RPM21B7	173,800	RPM31B7	239,800	RPM41B7	260,700
48 Vac	RPM11E7	123,200	RPM21E7	173,800	RPM31E7	239,800	RPM41E7	260,700
120 Vac	RPM11F7	123,200	RPM21F7	173,800	RPM31F7	239,800	RPM41F7	260,700
230 Vac	RPM11P7	123,200	RPM21P7	182,600	RPM31P7	239,800	RPM41P7	260,700



Power relays with LED (sold in lots of 10)

Coil Voltage	Number and type of contacts - Thermal current (Ith)							
	1 C/O - 15 A		2 C/O - 15 A		3 C/O - 15 A		4 C/O - 15 A	
	Reference	Unit Price	Reference	Unit Price	Reference	Unit Price	Reference	Unit Price
12 Vdc	RPM12JD	154,000	RPM22JD	201,300	RPM32JD	264,000	RPM42JD	287,100
24 Vdc	RPM12BD	154,000	RPM22BD	201,300	RPM32BD	264,000	RPM42BD	287,100
48 Vdc	RPM12ED	168,300	RPM22ED	234,300	RPM32ED	295,900	RPM42ED	313,500
110 Vdc	RPM12FD	168,300	RPM22FD	234,300	RPM32FD	295,900	RPM42FD	313,500
24 Vac	RPM12B7	151,800	RPM22B7	203,500	RPM32B7	268,400	RPM42B7	287,100
48 Vac	RPM12E7	151,800	RPM22E7	203,500	RPM32E7	268,400	RPM42E7	287,100
120 Vac	RPM12F7	151,800	RPM22F7	203,500	RPM32F7	268,400	RPM42F7	287,100
230 Vac	RPM12P7	151,800	RPM22P7	203,500	RPM32P7	268,400	RPM42P7	287,100



Socket for RPM relays (sold in lots of 10)

Contact terminal arrangement	Relay type	Reference	Unit Price
Screw clamp terminals	RPM1....	RPZF1	103,400
	RPM2....	RPZF2	148,500
	RPM3....	RPZF3	151,800
	RPM4....	RPZF4	202,400

Miniature relays, Medium Range

Relays with standard function from 3A to 5A

- Mechanical indication of relay status (standard)
- Green LED indication of relay status (depending on version)

Refer to Catalog 8501CT0601 on www.schneider-electric.com

Dòng relay tính năng cơ bản với dòng điện 3 A đến 5 A

- Cờ báo trạng thái tiếp điểm (có sẵn)
- Đèn Led báo trạng thái của relay (theo loại)



Unit price (incl.VAT) in VND

Optimum REXO Relays without LED indicator (Sold in lots of 10)

Description	Number of contacts	Coil supply voltage	Reference	Unit Price
Thermal current Ith=3A, Material of contact is Silver Alloy	4 C/O	12 VDC	RXM4LB1JD	123,200
		24 VDC	RXM4LB1BD	123,200
		48 VDC	RXM4LB1ED	123,200
		24 VAC	RXM4LB1B7	128,700
		120 VAC	RXM4LB1F7	128,700
		230 VAC	RXM4LB1P7	128,700
Thermal current Ith=5A, Material of contact is Silver Alloy	2 C/O	12 VDC	RXM2LB1JD	113,300
		24 VDC	RXM2LB1BD	113,300
		48 VDC	RXM2LB1ED	113,300
		24 VAC	RXM2LB1B7	113,300
		120 VAC	RXM2LB1F7	113,300
		230 VAC	RXM2LB1P7	113,300

Optimum REXO Relays with LED indicator (Sold in lots of 10)

Description	Number of contacts	Coil supply voltage	Reference	Unit Price
Thermal current Ith=3A, Material of contact is Silver Alloy	4 C/O	12 VDC	RXM4LB2JD	133,100
		24 VDC	RXM4LB2BD	133,100
		36 VDC	RXM4LB2CD	133,100
		48 VDC	RXM4LB2ED	133,100
		110 VDC	RXM4LB2FD	138,600
		24 VAC	RXM4LB2B7	138,600
		120 VAC	RXM4LB2F7	138,600
		230 VAC	RXM4LB2P7	138,600
Thermal current Ith=5A, Material of contact is Silver Alloy	2 C/O	12 VDC	RXM2LB2JD	122,100
		24 VDC	RXM2LB2BD	122,100
		36 VDC	RXM2LB2CD	122,100
		48 VDC	RXM2LB2ED	122,100
		110 VDC	RXM2LB2FD	122,100
		24 VAC	RXM2LB2B7	122,100
		120 VAC	RXM2LB2F7	122,100
		230 VAC	RXM2LB2P7	122,100

Socket for REXO Optimum Relays (Sold in lots of 10)

Description	Reference	Unit Price
Socket, mixed 2 poles, screw clamp, 7A, 22,5mm	RXZE1M2C	58,300
Socket, mixed 4 poles, screw clamp, 7A, 29mm	RXZE1M4C	78,100

(2) Socket can be used for relays with or without LED indicator

Miniature relays, Premium Range

The most demanding relays from 3A to 12A

- Mechanical indication of relay status (standard)
- Spring return test button for testing the contacts (standard)
- Green LED indication of relay status (depending on version)
- Plug-in protection module to protect against electrical spikes
- Plug-in jumper bars for coil terminals to avoid time-consuming wiring

Refer to Catalog 8501CT0601 on www.schneider-electric.com

Dòng relay kiếng phổ biến nhất với dòng điện 3 A đến 12 A

- Cờ báo trạng thái tiếp điểm (có sẵn)
- Nút ấn tự nhà để thử tiếp điểm (có sẵn)
- Đèn Led báo trạng thái của relay (theo loại)
- Các module bảo vệ sốc dòng điện
- Cầu đấu chung các cuộn coil tiết kiệm thời gian đấu nối

Unit price (incl.VAT) in VND

Miniature relays without LED (sold in lots of 10)



Coil Voltage	Number and type of contacts - Thermal current (Ith)					
	2 C/O - 12 A		3 C/O - 10 A		4 C/O - 6 A	
	Reference	Unit Price	Reference	Unit Price	Reference	Unit Price
12 Vdc	RXM2AB1JD	159,500	RXM3AB1JD	182,600	RXM4AB1JD	227,700
24 Vdc	RXM2AB1BD	159,500	RXM3AB1BD	182,600	RXM4AB1BD	227,700
48 Vdc	RXM2AB1ED	159,500	RXM3AB1ED	182,600	RXM4AB1ED	227,700
110 Vdc	RXM2AB1FD	159,500	RXM3AB1FD	191,400	RXM4AB1FD	237,600
220 Vdc					RXM4AB1MD	237,600
24 Vac	RXM2AB1B7	170,500	RXM3AB1B7	191,400	RXM4AB1B7	237,600
48 Vac			RXM3AB1E7	191,400	RXM4AB1E7	237,600
120 Vac	RXM2AB1F7	170,500	RXM3AB1F7	191,400	RXM4AB1F7	237,600
230 Vac	RXM2AB1P7	170,500	RXM3AB1P7	191,400	RXM4AB1P7	237,600
240 Vac					RXM4AB1U7	237,600

Socket and accessories on next page

Miniature relays with LED (sold in lots of 10)



Coil Voltage	2 C/O - 12 A		3 C/O - 10 A		4 C/O - 6 A	
	Reference	Unit Price	Reference	Unit Price	Reference	Unit Price
12 Vdc	RXM2AB2JD	173,800	RXM3AB2JD	196,900	RXM4AB2JD	245,300
24 Vdc	RXM2AB2BD	173,800	RXM3AB2BD	196,900	RXM4AB2BD	245,300
48 Vdc	RXM2AB2ED	173,800	RXM3AB2ED	196,900	RXM4AB2ED	245,300
110 Vdc	RXM2AB2FD	184,800	RXM3AB2FD	204,600	RXM4AB2FD	255,200
125 Vdc					RXM4AB2GD	255,200
24 Vac	RXM2AB2B7	184,800	RXM3AB2B7	204,600	RXM4AB2B7	255,200
48 Vac	RXM2AB2E7	184,800	RXM3AB2E7	204,600	RXM4AB2E7	255,200
120 Vac	RXM2AB2F7	184,800	RXM3AB2F7	204,600	RXM4AB2F7	255,200
230 Vac	RXM2AB2P7	184,800	RXM3AB2P7	204,600	RXM4AB2P7	255,200

Refer to Catalog 8501CT0601 on www.schneider-electric.com



Unit price (incl.VAT) in VND

Sockets (sold in lots of 10)

Contact terminal	Connection	Relay type	Reference	lth	Unit Price
	Screw clamp terminals	RXM2••••	RXZE2M114	10	108,900
		RXM4••••			
Mixed	Box lug connector	RXM2••••	RXZE2M114M	10	108,900
		RXM4••••			
		RXM2••••	RXZE2S108M	10	108,900
Separate	Box lug connector	RXM3••••	RXZE2S111M	10	108,900
		RXM4••••	RXZE2S114M	10	115,500

a When mounting relay RXM2•••• on socket RXZE2M••••, the thermal current must not exceed 10 A.

Protection modules (sold in lots of 20)

Description	Voltage	For use with	Reference	Unit Price
Diode	6-250 Vdc	All sockets	RXM040W	60,500
RC circuit	24-60 Vac	All sockets	RXM041BN7	60,500
	110-240 Vac	All sockets	RXM041FU7	60,500
Varistor	6-24 Vac/Vdc	All sockets	RXM021RB	60,500
	24-60 Vac/Vdc	All sockets	RXM021BN	60,500
	110-240 Vac/Vdc	All sockets	RXM021FP	60,500

Accessories

Description	For use with	Reference	Lot Size	Unit Price
Metal hold-down clip	All sockets	RXZ400	10	13,200
Plastic hold-down clip	All sockets	RXZR335	10	12,100
Bus jumper, 2-pole (lth: 5 A)	Sockets with separate contacts	RXZS2	10	9,900
Clip-in markers	All relays (108 pcs per lot)	RXZL520	10	169,400
	All sockets except RXZE2M114	RXZL420	10	4,400

Interface relays

- Interface relay from 5A to 10A
- 16mm width
- 1CO or 2CO
- LED indication of relay status
- Mechanical indication of relay status
- Test button for testing the contacts
- Used for PLC interface

RXG relays

- Dòng relay nhỏ gọn với dòng điện từ 5A đến 10A
- Bề rộng 16mm
- 1CO hoặc 2 CO
- Đèn LED báo trạng thái (theo loại)
- Cờ báo trạng thái tiếp điểm (có sẵn)
- Nút nhấn thử tiếp điểm tự giữ (theo loại)
- Thích hợp làm relay trung gian cho ngõ ra PLC, giúp tiết kiệm không gian tủ

Unit price (incl.VAT) in VND

RXG relays + LED + Test button



RXG•2••

Coil Voltage	Reference	Number and type of contacts - Current			Reference	Lot size	Unit Price
		1 C/O - 10A		2 C/O - 5A			
6VDC	RXG12RD	200	130,900	RXG22RD	200	152,900	
12VDC	RXG12JD	10	130,900	RXG22JD	10	152,900	
24VDC	RXG12BD	10	130,900	RXG22BD	10	152,900	
48VDC	RXG12ED	200	130,900	RXG22ED	10	152,900	
60VDC	RXG12ND	200	130,900	RXG22ND	200	152,900	
110VDC	RXG12FD	10	130,900	RXG22FD	200	152,900	
24VAC	RXG12B7	10	183,700	RXG22B7	10	205,700	
48VAC	RXG12E7	200	183,700	RXG22E7	10	205,700	
120VAC	RXG12F7	10	183,700	RXG22F7	10	205,700	
230VAC	RXG12P7	10	183,700	RXG22P7	10	205,700	

RXG relays + LED



RXG•3••

Coil Voltage	Reference	Number and type of contacts - Current			Reference	Lot size	Unit Price
		1 C/O - 10A		2 C/O - 5A			
6VDC	RXG13RD	200	95,700	RXG23RD	200	117,700	
12VDC	RXG13JD	10	95,700	RXG23JD	10	117,700	
24VDC	RXG13BD	10	95,700	RXG23BD	10	117,700	
48VDC	RXG13ED	200	95,700	RXG23ED	200	117,700	
60VDC	RXG13ND	200	95,700	RXG23ND	200	117,700	
110VDC	RXG13FD	200	95,700	RXG23FD	10	117,700	
24VAC	RXG13B7	10	148,500	RXG23B7	10	170,500	
48VAC	RXG13E7	200	148,500	RXG23E7	200	170,500	
120VAC	RXG13F7	10	148,500	RXG23F7	200	170,500	
230VAC	RXG13P7	10	148,500	RXG23P7	10	170,500	

Interface relays

- Interface relay from 5A to 10A
- 16mm width
- 1CO or 2CO
- LED indication of relay status
- Mechanical indication of relay status
- Test button for testing the contacts
- Used for PLC interface

RXG relays

- Dòng relay nhỏ gọn với dòng điện từ 5A đến 10A
- Bề rộng 16mm
- 1CO hoặc 2CO
- Đèn LED báo trạng thái (theo loại)
- Cờ báo trạng thái tiếp điểm (có sẵn)
- Nút nhấn thử tiếp điểm tự giữ (theo loại)
- Thích hợp làm relay trung gian cho ngõ ra PLC, giúp tiết kiệm không gian tủ

Unit price (incl.VAT) in VND

RXG relays Clear (no LED, no test button)



RXG•5••



RGZE1S48M



RZM031RB



RSZL300

Number and type of contacts - Current

Coil Voltage	Reference	1 C/O - 10A		2 C/O - 5A		
		Lot size	Unit Price	Reference	Lot size	Unit Price
6VDC	RXG15RD	240	88,000	RXG25RD	240	108,900
12VDC	RXG15JD	240	88,000	RXG25JD	10	108,900
24VDC	RXG15BD	10	88,000	RXG25BD	10	108,900
48VDC	RXG15ED	240	88,000	RXG25ED	240	108,900
60VDC	RXG15ND	240	88,000	RXG25ND	240	108,900
110VDC	RXG15FD	240	88,000	RXG25FD	240	108,900
24VAC	RXG15B7	10	139,700	RXG25B7	10	161,700
48VAC	RXG15E7	240	139,700	RXG25E7	240	161,700
120VAC	RXG15F7	240	139,700	RXG25F7	10	161,700
230VAC	RXG15P7	10	139,700	RXG25P7	240	161,700

Sockets

Description	Reference	Lot size	Unit Price
1 C/O Separate contact -10 A - 250 V - Screw connector	RGZE1S35M	10	79,200
2 C/O Separate contact -5 A - 250 V - Screw connector	RGZE1S48M	10	95,700

Protection Modules (same with RSB relays)

Description	For use with	Voltage	Reference	Lot size	Unit Price
Diode	All sockets	6-230 VDC	RZM040W	10	68,200
RC circuit	All sockets	24-60 VAC	RZM041BN7	10	143,000
		110-240 VAC	RZM041FU7	10	156,200
Diode + green LED	All sockets	6-24 VDC	RZM031RB	10	129,800
		24-60 VDC	RZM031BN	10	140,800
Varistor + green LED	All sockets	110-230 VDC	RZM031FPD	10	211,200
		6-24 VAC/DC	RZM021RB	10	216,700
		24-60 VAC/DC	RZM021BN	10	216,700
		110-230 VAC/DC	RZM021FP	10	227,700

Accessories (same with RSB relays)

Description	For use with	Reference	Lot size	Unit Price
Plastic hold-down clip	All sockets	RSZR215	10	9,900
Legend	All sockets	RSZL300	10	6,600

- Relays for standard applications at 8 A, 12 A, and 16 A.
- Plug-in protection module available to protect against electrical spikes
- Socket or printed circuit board installation

- Dòng relay cơ bản với dòng điện từ 8 A, 12 A và 16 A
- Các modul bảo vệ chống sốc do phóng điện
- Đầu nối trên để cắm hoặc trực tiếp lên mạch in

Refer to Catalog 8501CT0601 on www.schneider-electric.com

Unit price (incl.VAT) in VND

RSB Relays for standard applications (sold in lots of 10)

Coil Voltage	Number and type of contacts - Thermal current (Ith)					
	1 C/O - 12 A		1 C/O - 16 A		2 C/O - 8 A	
	Reference	Unit Price	Reference	Unit Price	Reference	Unit Price
6 Vdc	RSB1A120RD	81,400	RSB1A160RD	84,700	RSB2A080RD	93,500
12 Vdc	RSB1A120JD	88,000	RSB1A160JD	90,200	RSB2A080JD	99,000
24 Vdc	RSB1A120BD	88,000	RSB1A160BD	92,400	RSB2A080BD	99,000
48 Vdc	RSB1A120ED	97,900	RSB1A160ED	100,100	RSB2A080ED	112,200
60 Vdc	RSB1A120ND	97,900			RSB2A080ND	115,500
110 Vdc	RSB1A120FD	125,400	RSB1A160FD	130,900	RSB2A080FD	146,300
24 Vac	RSB1A120B7	150,700	RSB1A160B7	158,400	RSB2A080B7	171,600
48 Vac	RSB1A120E7	145,200	RSB1A160E7	148,500	RSB2A080E7	171,600
120 Vac	RSB1A120F7	169,400	RSB1A160F7	177,100	RSB2A080F7	193,600
220 Vac	RSB1A120M7	216,700	RSB1A160M7	212,300	RSB2A080M7	227,700
230 Vac	RSB1A120P7	224,400	RSB1A160P7	236,500	RSB2A080P7	261,800
240 Vac	RSB1A120U7	262,900	RSB1A160U7	275,000	RSB2A080U7	279,400



Sockets - 12 A, 300 Vac

Contact terminal	Relay type	Reference	Unit Price
Separate	RSB1A120**	RSZE1S35M	217,800
	RSB1A160**		
	RSB2A080**	RSZE1S48M	224,400

Protection modules (sold in lots of 10)

Description	For use with	Voltage	Reference	Unit Price
Diode	All sockets	6-230 VDC	RZM040W	68,200
RC circuit	All sockets	24-60 VAC	RZM041BN7	143,000
		110-240 VAC	RZM041FU7	156,200
Diode + green LED	All sockets	6-24 VDC	RZM031RB	129,800
		24-60 VDC	RZM031BN	140,800
		110-230 VDC	RZM031FPD	211,200
Varistor + green LED	All sockets	6-24 VAC/DC	RZM021RB	216,700
		24-60 VAC/DC	RZM021BN	216,700
		110-230 VAC/DC	RZM021FP	227,700

Accessories (sold in lots of 10)

Description	For use with	Reference	Unit Price
Plastic hold-down clip	All sockets	RSZR215	9,900
Marker	All sockets	RSZL300	6,600

ZELIO ELECTRONIC RELAY



- Dial pointer LED to make set up easier at dark ambience
- “Diagnostic button” to check downstream circuit immediately, shorten the commission and troubleshooting time

Featured ! The One and Only in the market

APPLICATION

Measurement and control relay RM22/RM35

**Phase control
Current control**

True RMS Input Measurement

TRUE RMS detection eliminates any possibilities of nuisance trips from highly polluted networks
(Only applicable to 3 phase, voltage & current range)

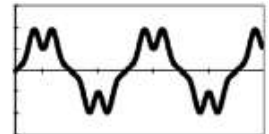

Doubled Surge Immunity

Level III → Level IV
1kV/2k[DM/CM] → 2kV/4k[DM/CM]
Stand-out amongst its competitors, guarantees robustness in tough environments



Level control

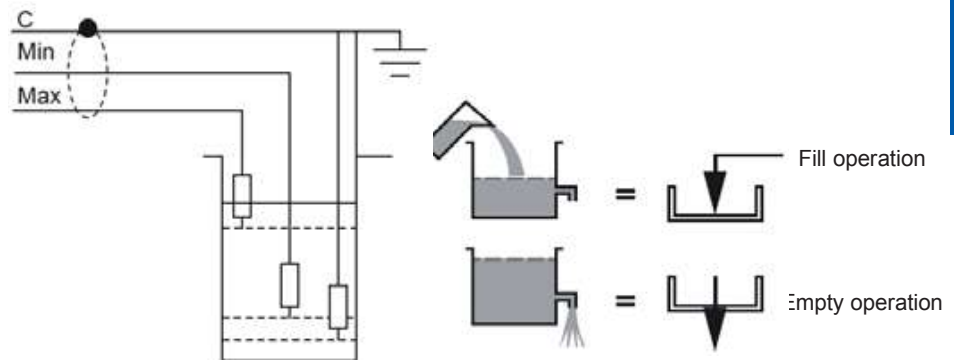

Timer relay RE22



ON/ OFF Delay

Flashing

Multi Function

RƠ-LE ĐIỆN TỬ ZELIO



- Đèn báo trên con trở hỗ trợ cài đặt trong điều kiện thiếu sáng
- “Diagnostic button”- nút thử tiếp điểm, mô phỏng trạng thái ngắt của rơ-le để kiểm tra mạch

Sản phẩm duy nhất trên thị trường có thiết kế này !!!

ỨNG DỤNG

Rơ-le bảo vệ và điều khiển RM22/RM35

**Bảo vệ pha
Bảo vệ dòng**

Đo trị hiệu dụng thực True RMS

Đo chính xác giá trị dòng/áp, tránh trường hợp ngắt sai khi nguồn điện bị nhiễu nặng
(chỉ áp dụng cho sản phẩm bảo vệ 3 pha, điện áp và dòng)

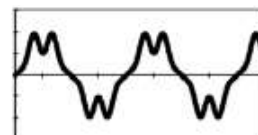

Điều khiển mức

Khả năng chống xung điện áp cao

Level III → Level IV
1kV/2k[DM/CM] → 2kV/4k[DM/CM]
Vượt xa mọi sản phẩm hiện tại trên thị trường,
Đảm bảo độ bền trong môi trường khắc nghiệt

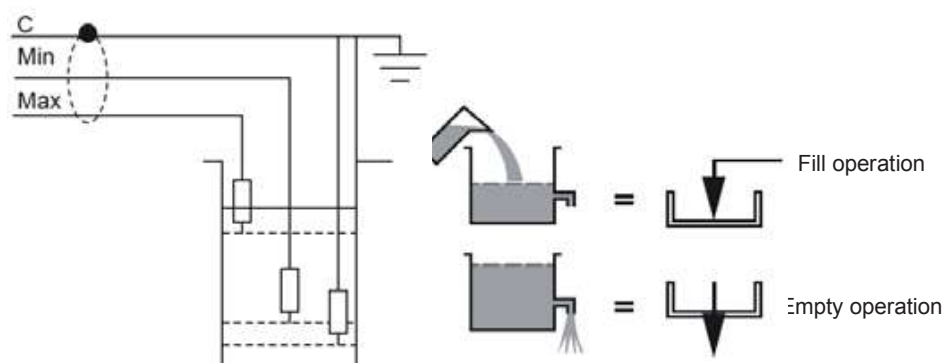

Rơ-le thời gian RE22



Đóng/ Mở trễ

Chớp-tắt

Đa chức năng

Measurement and control relay RM22/RM35

Measurement and control relay RM22 (22mm), RM35 (35mm) for DIN rail:

- True RMS measurement
- Surge immunity at 4kV (conforming with IEC61000-4-5)
- LED pointer
- Diagnostic button

Application:

- Over/Under voltage protection
- Phase failure, phase sequence, asymmetry
- Over/Under current protection
- Level control for conductive liquid

Dòng relay bảo vệ gắn DIN rail RM22 (22mm), RM35 (35mm):

- Khả năng đo trị hiệu dụng thực cho độ chính xác cao không ảnh hưởng bởi sóng hài
- Khả năng chịu xung điện áp 4kV (theo chuẩn IEC61000-4-5)
- Đèn LED trên con trở cài đặt
- Nút nhấn thử tiếp điểm

Ứng dụng:

- Bảo vệ quá áp/ thấp áp
- Bảo vệ mất pha, thứ tự pha, mất cân bằng pha
- Bảo vệ quá dòng/ thấp dòng
- Điều khiển mức đối với các chất lỏng dẫn điện

Unit price (incl.VAT) in VND

Multifunction 3-phase control relays

Function	Rated supply voltage	Measurement range	Time delay	Output	Reference	Unit Price
• Phase sequence • Phase failure	208...480 VAC	183...528 VAC	No	2 C/O 8 A	RM22TG20	1,437,700
• Phase sequence • Phase failure • Undervoltage	200...240 VAC	200...240 VAC	Off delay (0.1...30 s)	2 C/O 8 A	RM22TR31	2,492,600
• Overvoltage • Phase sequence • Phase failure	380...480 VAC	380...480 VAC	Off delay (0.1...30 s)	2 C/O 8 A	RM22TR33	3,102,000
• Asymmetry	200...240 VAC	200...240 VAC	Off delay (0.1...30 s)	2 C/O 8 A	RM22TA31	2,403,500
• Phase sequence • Phase failure	380...480 VAC	380...480 VAC	Off delay (0.1...30 s)	2 C/O 8 A	RM22TA33	2,425,500
• Phase sequence • Phase failure	200...240 VAC	200...240 VAC	No	2 C/O 8 A	RM22TU21	2,270,400
• Undervoltage	380...480 VAC	380...480 VAC	No	2 C/O 8 A	RM22TU23	2,289,100

1-phase or DC voltage control relays

Function	Rated supply voltage	Measurement range	Time delay	Output	Reference	Unit Price
• Overvoltage and undervoltage with/without memory	24...240 VDC/AC	0.05...5 VDC/AC	Off delay (0.1...30 s)	2 C/O 8 A	RM22UA31MR	3,724,600
• Overvoltage and undervoltage with memory window	24...240 VDC/AC	1...100 VDC/AC	Off delay (0.1...30 s)	2 C/O 8 A	RM22UA32MR	2,901,800
	24...240 VDC/AC	15...500 VDC/AC	Off delay (0.1...30 s)	2 C/O 8 A	RM22UA33MR	2,901,800

Current control relays

Function	Rated supply voltage	Measurement range(mA)	Time delay	Output	Reference	Unit Price
• Overcurrent with/without memory • Undercurrent with/without memory	24...240 VDC/AC	4...1000 DC/AC	Off delay (0.1...30 s)	2 C/O 8 A	RM22JA31MR	2,786,300
• Overcurrent and undercurrent (windows mode) with/without memory	24...240 VDC/AC	150...15000 DC/AC	Off delay (0.1...30 s)	2 C/O 8 A	RM35JA32MR	2,995,300

Liquid level control relay

Function	Rated supply voltage	Measurement range(mA)	Time delay	Output	Reference	Unit Price
• Level 1/Level 2 • Fill operation	24...240 VDC/AC	5 K...100 KΩ	No	1 C/O 8 A	RM22LG11MR	1,971,200
• Empty operation	24...240 VDC/AC	250...1 MΩ	On/Off (0.1...30 s)	2 C/O 8 A	RM22LA32MR	2,332,000



RM22TG20



RM22TR33



RM35JA32MR



RM22LG11MR

Timing relays RE22

For more details about timing relays, see the catalogue number DIA5ED2130103EN on www.schneider-electric.com



RE22R1AMR

Unit price (incl.VAT) in VND

RM22 modular Timers - 22mm wide

Timing Range	Functions	Output	Voltages	Reference	Unit Price
	Delay ON	1 C/O	24...240 VDC/AC	RE22R1AMR	1,053,800
	A, Aw	2 C/O	24...240 VDC/AC	RE22R2AMR	1,490,500
	Delay OFF	1 C/O	24...240 VDC/AC	RE22R1KMR	1,229,800
	K				
10 selectable timing ranges: 1s, 3s, 10s, 30s, 100s, 300s, 30min, 300min, 30h, 300h	Multi-function A, At, Aw, Ac, Act, C, Ct, D, Dt, Dw, Di, Dit, Diw, H, Ht, Hw,W, Wt,	1 C/O	24...240 VDC/AC	RE22R1MYMR	1,730,300
	A, At, Aw, C, Ct, D, Dt, Dw, Di, Dit, Diw, H, Ht, Hw, Qg, Qgt, Qt, Qtt, W, Wt	2 C/O	24...240 VDC/AC	RE22R2MYMR	2,511,300
7 selectable timing ranges: 0.5s, 1s, 3s, 10s, 30s, 100s, 300s	Qc	1 C/O	24 VDC 24...240 VAC	RE22R1QCMU	1,001,000
Single range selection 30s	Qe	2 C/O	24...240 VDC/AC	RE22R2QEMR	1,160,500

- | | | | |
|-----|---|-----|--|
| A | Power on-delay relay | Diw | Symmetrical flashing relay (starting pulse-on) with retrigger/restart control signal |
| At | Power on-delay relay with pause/summation control signal | H | Interval relay |
| Aw | Power on-delay relay with retrigger/restart control signal | Ht | Interval relay with pause/summation control signal |
| Ac | On-delay and off-delay relay with control signal | Hw | Interval relay with retrigger/restart control signal |
| Act | On-delay and off-delay relay with control signal and pause/summation control signal | W | Interval relay with control signal off |
| C | Off-delay relay with control signal | Wt | Interval relay with control signal off and pause/summation control signal |
| Ct | Off-delay relay with control signal and pause/summation control signal | Qc | Star-delta timing (1 C/O output) |
| D | Symmetrical flashing relay (starting pulse-off) | Qe | Star-delta timing (1 N/C + 1 N/O outputs with split common) |
| Dt | Symmetrical flashing relay (starting pulse-off) with pause/summation control signal | | |
| Dw | Symmetrical flashing relay (starting pulse-off) with retrigger/restart control signal | | |
| Di | Symmetrical flashing relay (starting pulse-on) | | |

For detail of timing function, please scan the QR code for instruction



Timing relays

For more details about timing relays, see the catalogue number DIA3ED2051205EN on www.schneider-electric.com

Unit price (incl.VAT) in VND

RE17 Modular Timers-17.9 mm wide (Multi-range timers offering 7 selectable ranges), Output 1 C/O contact



Functions	Timing Range	Supply Voltages	Rated Current	Reference	Unit Price
On delay	A	24 Vdc, 24–240 Vac	8A	RE17RAMU	940,500
Interval	A	24 Vdc, 24–240 Vac	8A	RE17RHMU	1,016,400
Asymmetrical repeat cycle	A	24 Vdc, 24–240 Vac	8A	RE17RLMU	905,300
Asymmetrical repeat cycle	A	12 Vac/Vdc	8A	RE17RLJU	1,016,400
One shot	A	24 Vdc, 24–240 Vac	8A	RE17RBMU	940,500
Off delay with control start	A	24 Vdc, 24–240 Vac	8A	RE17RCMU	1,016,400
Multi-function	A	24 Vdc, 24–240 Vac	8A	RE17RMMU	1,398,100
Multi-function	A	12–240 Vac/Vdc	8A	RE17RMMW	1,463,000
Multi-function	A	12–240 Vac/Vdc	8A	RE17RMMWS	1,272,700
Multi-function	A	12 Vac/Vdc	8A	RE17RMJU	1,322,200
Multi-function	A	24 Vdc, 24–240 Vac	5A	RE17RMEMU	1,144,000
Multi-function	A	24 Vdc, 24–240 Vac	8A	RE17RMXMU	1,116,500

A Timing ranges: 0.1–1 s, 1–10 s, 0.1–10 min, 1–10 min, 0.1–1 hr, 1–10 hr, 10–100 hr

B Timing ranges: 0.1–1 s, 1–10 s, 0.1–10 min, 1–10 min, 0.1–1 hr, 1–10 hr

RE17 Modular Timers-17.9 mm wide (Multi-function, dual function or single function, Solid state output)



Functions	Supply Voltages	Rated Current	Reference	Unit Price
On delay	24–240 Vac/Vdc	0.7A	RE17LAMW	1,194,600
Interval	24–240 Vac	0.7A	RE17LHBM	1,094,500
Off delay with control contact	24–240 Vac	0.7A	RE17LCBM	1,094,500
Asymmetrical repeat cycle	24–240 Vac	0.7A	RE17LLBM	1,170,400
Multi-function	24–240 Vac	0.7A	RE17LMBM	1,475,100

Timing ranges: 0.1–1 s, 1–10 s, 0.1–10 min, 1–10 min, 0.1–1 hr, 1–10 hr, 10–100 hr

RE48 Front Panel Mount Timers,

Functions	Supply Voltages	Rated Current	Reference	Unit Price
Single function: on delay, two relay outputs	24–240 Vac/Vdc	2 x 5 A	RE48ATM12MW	1,606,000
Repeat cycle: two relay outputs	24–240 Vac/Vdc	2 x 5 A	RE48ACV12MW	1,910,700
Multi-function: on delay, one shot, off delay, repeat cycle	24–240 Vac/Vdc	2 x 5 A	RE48AML12MW	1,910,700
Multi-function: on delay and interval, two relay outputs, of which one selectable and instantaneous	24–240 Vac/Vdc	2 x 5 A	RE48AMH13MW	2,048,200

Timing ranges: 1.2 s, 3 s, 12 s, 30 s, 120 s, 300 s, 12 min, 30 min, 120 min, 300 min, 12 h, 30 h, 120 h, 300 h

Socket for RE48 timer (Sold in lots of 10)

8 pin	For use with RE48ATM12MW, RE48AMH13MW	RUZC2M	74,800
11 pin	For use with RE48ACV12MW, RE48AML12MW	RUZC3M	103,400

REXL Miniature Plug-in Timers, Single function (On-Delay)



REXL

Functions	Supply Voltages	Rated Current	4 C/O		2 C/O		
			Reference	Unit Price	Reference	Unit Price	
On - Delay	12 Vdc	3A	REXL4TMJD	935,000	5A	REXL2TMJD	860,200
	24 Vdc	3A	REXL4TMBD	935,000	5A	REXL2TMBD	860,200
	24 Vac	3A	REXL4TMB7	935,000	5A	REXL2TMB7	860,200
	120 Vac	3A	REXL4TMF7	935,000	5A	REXL2TMF7	860,200
	230 Vac	3A	REXL4TMP7	935,000	5A	REXL2TMP7	860,200

Timing Ranges: 0.1–1 s, 1–10 s, 0.1–1 min, 1–10 min, 0.1–1 hr, 1–10 hr, 10–100 hr

- For 48 Vac supply, additional resistor 390 ohm 4 W / 24 V

Socket for REXL timer (Sold in lots of 10)

For use with timers	REXL2●●●●	RXZE2S108M	108,900
For use with timers	REXL4●●●●	RXZE2S114M	115,500

Telemecanique Sensors

The essential guide of Detection



Simply easy!™



Telemecanique Sensors

Simply easy!™*

Founded over 90 years ago, **Telemecanique Sensors** is specialized in sensors and sensor-related technology.

As a **global leader** in the sensors business, we help our customers select the right technology to get the best performance and reliability from their machines.

Focused on 3 core values – **Simplicity, Proximity and Expertise** – we have become experts in factory automation sensors as well as specialists in demanding applications, making our customers' lives "simply easy!"



Connect with the experts



Telemecanique Sensors team is available for pre and post sales support. We become an extension of your team and share our expertise with you.

www.tesensors.com

Telemecanique Sensors

Zoom on...

• Safety switches



◀ **Preventa™ XUSL**, the new safety Light Curtains, for an efficient protection of machine operators, for finger, hand and body

Preventa™ XY2CJ is the first emergency stop trip wire switch in compliance with NiSD certification according to the IEC 60947-5-5 standard. Colour coded sections on the pull reset button make the visualization of switch status easy and allow a quick machine restart.



◀ **The dual pre-cabled safety rope switch** is an easy way to increase safety all throughout the machine work zone. Enabling a pre-cabled length up to 2x100m, you can protect your personnel and machines better with **Preventa™ XY2CED**, emergency stop rope switch, easy to reach and trigger from everywhere in the work zone.

Preventa™ XCSR the new contactless safety switches RFID to secure the hazardous areas. High level of safety in a compact size, highly untamperable and easy to install



• Wireless limit switch

OsiSense™ XCKW enables wireless machine communication where cabling is difficult, expensive, or unwanted. It's also the perfect way to give mobile machines more freedom of movement.

To further simplify the installation process, the device comes in a plug & play kit, and is also offered in out-of-the-box compatible packs comprising an **OsiSense™ XCKW** limit switch and



• Photo Electric sensors

OsiSense™ XUK9T is a sensor for distance measurement. Its anti-collision mode and tandem mode are ideal for overhead cranes applications. It operates according to the Time of Flight (TOF) principle: light measured by time of flight.



◀ **OsiSense™ XG RFID**, the new Telemecanique Sensors reader XG RFID strengthens the machines safety via an innovative and easy-to-configure system. This new solution can be easily integrated into a control panel via a standard hole of 22mm. It will allow to differentiate the available functions in your machines depending on each user's profile.

• Inductive proximity sensors



◀ **OsiSense™ XS** is the first product combining both SIL2 certification from the TÜV and E2 certification dedicated to mobile equipment. Complementary outputs (NO+NC), combined with the high level of safety, guarantee the overall reliability of your installation, detecting instantly any failure (short cut, pre-cabled vulnerability, etc.).

• Sensors for pressure control

Latest sensor in the XMLP family **OsiSense™ XMLP** low pressure combines compact size and high reliability. Combining any **OsiSense™ XMLP** sensor with **OsiSense™ ZMLP**

display is an easy and economical way:

- to get a pressure switch function
- to have an on-device or remote pressure display delivering a clear view of accurate pressure information even if the conduit runs in a hard to access location.



Pressure switches: OsiSense XM

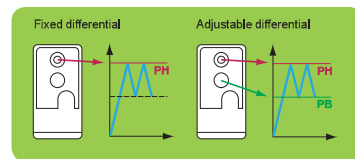
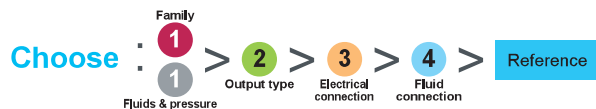

XMLA / XMLB Electromechanical		Hydraulic oils, air, fresh water, sea water / Temp. : up to 70° C							
Screw terminal		1 C/O single pole contact fixed differential			1 C/O single pole contact adjustable differential				
		Bar	psi	ISO M20	Pg13	DIN connector	ISO M20	Pg13	DIN connector
<p>1 C/O</p> <p>G 1/4 (female)</p>	-1	-14.5	XMLAM01V2S12	XMLAM01V2S11	XMLAM01V2C11	XMLBM02V2S12	XMLBM02V2S11	XMLBM02V2C11	
	2.5	36.3	XMLA002A2S12	XMLA002A2S11	XMLA002A2C11	XMLB002A2S12	XMLB002A2S11	XMLB002A2C11	
	4	58	XMLA004A2S12	XMLA004A2S11	XMLA004A2C11	XMLB004A2S12	XMLB004A2S11	XMLB004A2C11	
	10	145	XMLA010A2S12	XMLA010A2S11	XMLA010A2C11	XMLB010A2S12	XMLB010A2S11	XMLB010A2C11	
	20	290	XMLA020A2S12	XMLA020A2S11	XMLA020A2C11	XMLB020A2S12	XMLB020A2S11	XMLB020A2C11	
	35	508	XMLA035A2S12	XMLA035A2S11	XMLA035A2C11	XMLB035A2S12	XMLB035A2S11	XMLB035A2C11	
		Hydraulic oils / Temp. : up to 160° C							
	1	14.5	XMLA001R2S12	XMLA001R2S11	XMLA001R2C11	XMLB001R2S12	XMLB001R2S11	XMLB001R2C11	
	70	1015	XMLA070D2S12	XMLA070D2S11	XMLA070D2C11	XMLB070D2S12	XMLB070D2S11	XMLB070D2C11	
	160	2320	XMLA160D2S12	XMLA160D2S11	XMLA160D2C11	XMLB160D2S12	XMLB160D2S11	XMLB160D2C11	
	300	4350	XMLA300D2S12	XMLA300D2S11	XMLA300D2C11	XMLB300D2S12	XMLB300D2S11	XMLB300D2C11	
	500	7250	XMLA500D2S12	XMLA500D2S11	XMLA500D2C11	XMLB500D2S12	XMLB500D2S11	XMLB500D2C11	

XMLR Electronic + Display		Hydraulic oils, air, fresh water, refrigerant fluids					
M12 4 pin or 5 pin		-20... +80° C		Analogue output		Analogue + 2 switching outputs	
		Bar	psi	4...20 mA	0...10 V	PNP - NO/NC programmable	
<p>G 1/4A (female)</p>	-1	-14.5	XMLRM01G0T25	XMLRM01G0T75	XMLRM01G2P25		
	1	14.5	XMLR001G0T25	XMLR001G0T75			
	2.5	35.2	XMLR2D5G0T25	XMLR2D5G0T75			
	10	145	XMLR010G0T25	XMLR010G0T75	XMLR010G2P25		
	16	232	XMLR016G0T25	XMLR016G0T75	XMLR016G2P25		
	25	362	XMLR025G0T25	XMLR025G0T75			
	40	580	XMLR040G0T25	XMLR040G0T75	XMLR040G2P25		
	100	1450	XMLR100M0T25	XMLR100M0T75			
	160	2320	XMLR160M0T25	XMLR160M0T75			
	250	3625	XMLR250M0T25	XMLR250M0T75	XMLR250M2P25		
	400	5800	XMLR400M0T25	XMLR400M0T75	XMLR400M2P25		
	600	8700	XMLR600M0T25	XMLR600M0T75			
		-20... +80° C		Analogue + switching output		2 switching outputs	
		Bar	psi	PNP - NO/NC programmable		PNP - NO/NC programmable	
	-1	-14.5	XMLRM01G1P25	XMLRM01G1P75	XMLRM01G2P05		
	1	14.5	XMLR001G1P25	XMLR001G1P75	XMLR001G2P05		
	2.5	35.2	XMLR2D5G1P25	XMLR2D5G1P75	XMLR2D5G2P05		
	10	145	XMLR010G1P25	XMLR010G1P75	XMLR010G2P05		
	16	232	XMLR016G1P25	XMLR016G1P75	XMLR016G2P05		
	25	362	XMLR025G1P25	XMLR025G1P75	XMLR025G2P05		
	40	580	XMLR040G1P25	XMLR040G1P75	XMLR040G2P05		
	100	1450	XMLR100M1P25	XMLR100M1P75	XMLR100M2P05		
	160	2320	XMLR160M1P25	XMLR160M1P75	XMLR160M2P05		
	250	3625	XMLR250M1P25	XMLR250M1P75	XMLR250M2P05		
	400	5800	XMLR400M1P25	XMLR400M1P75	XMLR400M2P05		
	600	8700	XMLR600M1P25	XMLR600MP75	XMLR600M2P05		

Cabling XM		Connectors (female)			PUR pre wired connectors (female)*			PUR Jumper cables				
		M12		M12	M12		M12 (female)		M12 (male)			
		straight	elbowed	straight	elbowed	elbowed PNP LED	straight	elbowed	straight	straight		
(1)	4 pin	XZCC12FDM40B	XZCC12FCM40B	4 pin	2 m	XZCP1141L2	XZCP1241L2	XZCP1340L2	4 pin	1 m	XZCR1511041C1	XZCR1512041C1
(2)	4 pin	XZCC12FDP40B	XZCC12FCP40B	5 m	5 m	XZCP1141L5	XZCP1241L5	XZCP1340L5	2 m		XZCR1511041C2	XZCR1512041C2
(1)	5 pin	XZCC12FDM50B	XZCC12FCM50B	10 m		XZCP1141L10	XZCP1241L10	XZCP1340L10				

(1) Steel ring (2) Plastic ring

* For a PVC cable, add the letter V after the P. Example: XZCPxxxxx become XZCPVxxxxx

Pressure switches: OsiSense XM

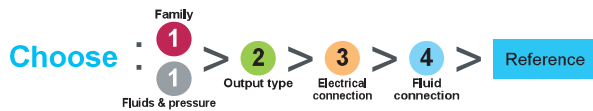

XMLP Electronic transmitter	Hydraulic oils, air, fresh water, refrigerant fluids					
	-30...+85° C		Analogue output			
	Bar	psi	4...20 mA	0...10 V	0.5...4.5 V	
M12 4 pin (male)			XMLPM00GD21F	XMLPM00GD71F	XMLPM00GD11F	
	-1	-14,5	XMLP001GD21F	XMLP001GD71F	XMLP001GD11F	
	1	14.5	XMLP006GD21F	XMLP006GD71F	XMLP006GD11F	
	6	87	XMLP010BD21F	XMLP010BD71F	XMLP010BD11F	
	10	145	XMLP016BD21F	XMLP016BD71F	XMLP016BD11F	
	16	232	XMLP025BD21F	XMLP025BD71F	XMLP025BD11F	
	25	362	XMLP040BD21F	XMLP040BD71F	XMLP040BD11F	
	40	580	XMLP060BD21F	XMLP060BD71F	XMLP060BD11F	
	60	870	XMLP100BD21F	XMLP100BD71F	XMLP100BD11F	
	100	1450	XMLP160BD21F	XMLP160BD71F	XMLP160BD11F	
	160	2320	XMLP250BD21F	XMLP250BD71F	XMLP250BD11F	
	250	3625	XMLP400BD21F	XMLP400BD71F	XMLP400BD11F	
	400	5800	XMLP600BD21F	XMLP600BD71F	XMLP600BD11F	
G 1/4A (male)	600	8700				

ZMLP Display and switch	4-20 mA analogue + switching output		2 switching outputs
	NO/NC Programmable		NO/NC Programmable
	Window	Hysteresis	Fixed hysteresis
M12 4 pin (male)	ZMLPA1P2SW	ZMLPA1P2SH	ZMLPA2P0SH
PNP			

Only usable with 4-20mA analogue output XMLP electronic transmitter

Quick fixing bracket	Horizontal plan	Vertical plan or pipe
		XMLPZLH01

Cabling XM

M12	Connectors (female)		PUR pre wired connectors (female)*			PUR Jumper cables			
	straight	elbowed	M12	straight	elbowed	elbowed PNP LED	M12 (female)	straight	elbowed
(1)	4 pin	XZCC12FDM40B XZCC12FCM40B	4 pin	2 m	XZCP1141L2 XZCP1241L2	XZCP1340L2	M12 (male)	straight	straight
(2)	4 pin	XZCC12FDP40B XZCC12FCP40B		5 m	XZCP1141L5 XZCP1241L5	XZCP1340L5	4 pin	1 m	XZCR1511041C1 XZCR1512041C1
(1)	5 pin	XZCC12FDM50B XZCC12FCM50B		10 m	XZCP1141L10 XZCP1241L10	XZCP1340L10		2 m	XZCR1511041C2 XZCR1512041C2

(1) Steel ring (2) Plastic ring

* For a PVC cable, add the letter V after the P. Example: XZCPxxxxx become XZCPVxxxxx

Limit switches: OsiSense XC



Choose: **1** > **2** > **3** > **4** > Reference

Body Head Contact Connection

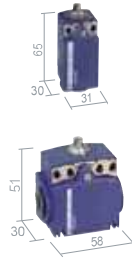

XCKD Metal	NO+NC Snap	M16	XCKD2110P16	XCKD2102P16	XCKD2121P16	XCKD2106P16	XCKD2118P16	XCKD2145P16						
		Pg11	XCKD2110G11	XCKD2102G11	XCKD2121G11	XCKD2106G11	XCKD2118G11	XCKD2145G11						
		M12 5P	XCKD2110M12	XCKD2102M12	XCKD2121M12	XCKD2106M12	XCKD2118M12	XCKD2145M12						
XCKP Plastic	NO+NC Snap	M16	XCKP2110P16	XCKP2102P16	XCKP2121P16	XCKP2106P16	XCKP2118P16	XCKP2145P16						
		Pg11	XCKP2110G11	XCKP2102G11	XCKP2121G11	XCKP2106G11	XCKP2118G11	XCKP2145G11						
		M12 4P	XCKP2110M12	XCKP2102M12	XCKP2121M12	XCKP2106M12	XCKP2118M12	XCKP2145M12						
XCKT Plastic	NO+NC Snap	M16	XCKT2110P16	XCKT2102P16	XCKT2121P16	XCKT2106P16	XCKT2118P16	XCKT2145P16						
		Pg11	XCKT2110G11	XCKT2102G11	XCKT2121G11	XCKT2106G11	XCKT2118G11	XCKT2145G11						



XCMD Metal	NO+NC Snap	1 m	XCMD2110L1	XCMD2102L1	XCMD2124L1	XCMD21F0L1	XCMD21F2L1	XCMD2115L1	XCMD2116L1					
	NO+NC Slow	1 m	XCMD2510L1	XCMD2502L1	XCMD2524L1	XCMD25F0L1	XCMD25F2L1	XCMD2515L1	XCMD2516L1					
	NO+NC Snap	M12 5P	XCMD2110C12	XCMD2102C12	XCMD2124C12	XCMD21F0C12	XCMD21F2C12	XCMD2115C12	XCMD2116C12					
	1 C/O Snap	M12 4P	XCMD2110M12	XCMD2102M12	XCMD2124M12	XCMD21F0M12	XCMD21F2M12	XCMD2115M12	XCMD2116M12					



XCKM Metal	NO+NC Snap	M20	XCKM110H29	XCKM102H29	XCKM121H29	XCKM115H29	XCKM106H29							
		Pg11	XCKM110	XCKM102	XCKM121	XCKM115	XCKM106							
XCKL Metal	NO+NC Snap	CG	XCKL110	XCKL102	XCKL121	XCKL115	XCKL106							



XCKJ Metal	NO+NC Snap	M20	XCKJ161H29	XCKJ167H29	XCKJ10511H29	XCKJ10513H29	XCKJ10541H29	XCKJ10559H29							
		Pg13	XCKJ161	XCKJ167	XCKJ10511	XCKJ10513	XCKJ10541	XCKJ10559							
		1/2NPT	XCKJ161H7	XCKJ167H7	XCKJ10511H7	XCKJ10513H7	XCKJ10541H7	XCKJ10559H7							
		M12 5P	XCKJ161D	XCKJ167D	XCKJ10511D	XCKJ10513D	XCKJ10541D	XCKJ10559D							

(1) Plastic roller (2) Steel roller

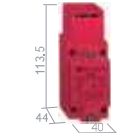

XCSA Metal		NC+2NO Slow												
		2NC+NO Slow												
		3NC Slow												
		Accessories												
			XCSA502	XCSA702	XCSA802	XCSZ01	XCSZ03							
			XCSA501	XCSA701	XCSA801									
			XCSA503	XCSA703	XCSA803									



XCSPA Plastic		NC+NO Slow												
		2NC Slow												
		2NO+NC Slow												
		2NC+NO Slow												
			XCSPA592	XCSPA792	XCSPA892	XCSPA992	XCSPA492	XCSZ11	XCSZ13					
			XCSPA591	XCSPA791	XCSPA891	XCSPA991	XCSPA491							
			XCSPA593	XCSPA793	XCSPA893	XCSPA993	XCSPA493							

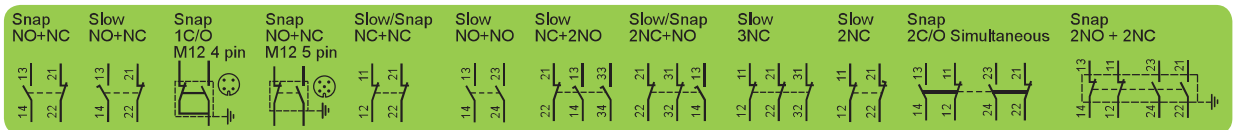

- M16 Tapped M16x1,5 for ISO cable gland
- M20 Tapped M20x1,5 for ISO cable gland
- Pg11 Tapped for a N°11 cable gland
- Pg13 Tapped for a N°13 cable gland
- 1/2NPT Tapped for a 1/2" NPT
- PF1/2 Tapped for a PF1/2"
- M12 5P Connector M12, 5 pin
- M12 4P Connector M12, 4 pin
- CG Tapped with cable gland included

Cabling XC

			PUR pre wired connectors (female)*			Connectors (female)		
			straight	elbowed	elbowed PNP LED	straight	elbowed	
M12	4 pin	2 m	XZCP1141L2	XZCP1241L2	XZCP1340L2	(1) 4 pin	XZCC12FDM40B	XZCC12FCM40B
		5 m	XZCP1141L5	XZCP1241L5	XZCP1340L5	(2) 4 pin	XZCC12FDP40B	XZCC12FCP40B
		10 m	XZCP1141L10	XZCP1241L10	XZCP1340L10	(1) 5 pin	XZCC12FDM50B	XZCC12FCM50B
		5 pin 5 m	XZCP1164L5	XZCP1264L5				

(1) Steel ring (2) Plastic ring

*For a PVC cable, add the letter V after the P. Example: XZCPxxxxx become XZCPVxxxxx

Limit switches: OsiSense XC



XCKP / XCKD / XCKT

Plastic / Metal / Plastic

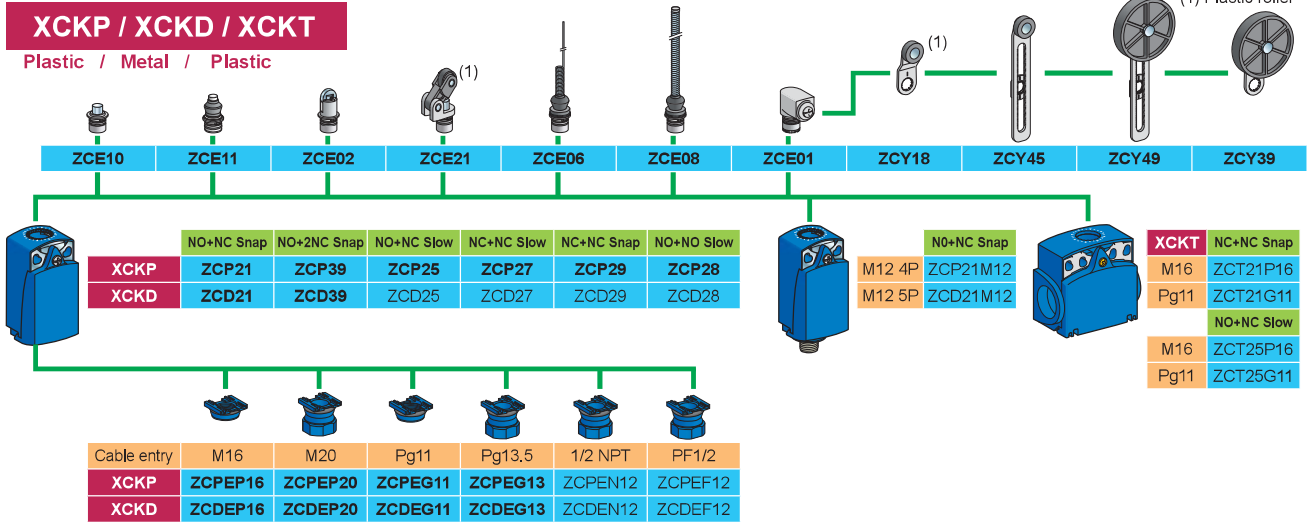

XCMD

Metal

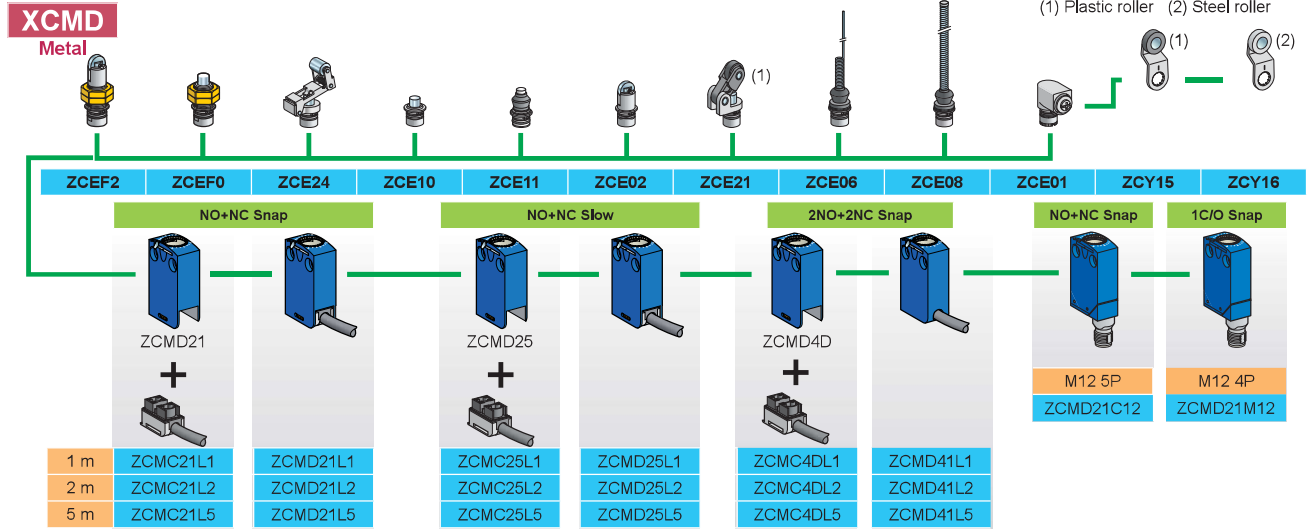

XCKM / XCKL

Metal / Metal

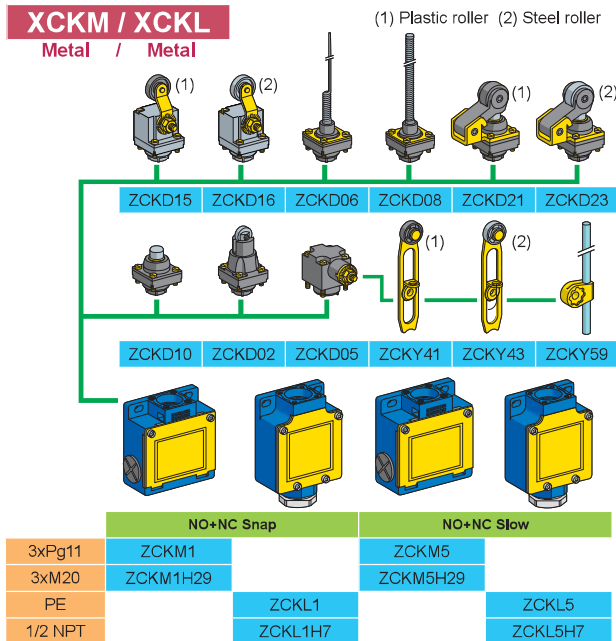

XCKJ

Metal

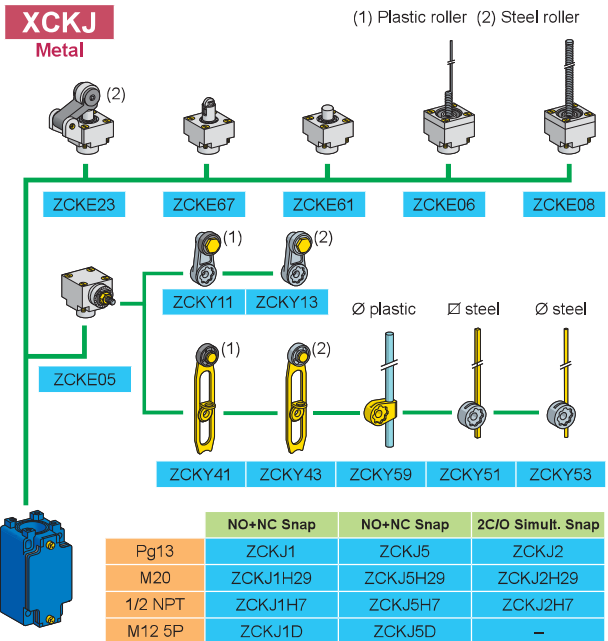

Inductives: OsiSense XS

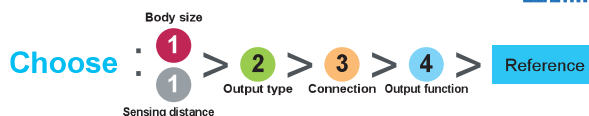

Flush mountable			M8				M12				
Sensing distance			1.5 mm		2.5 mm		2 mm		4 mm		
Short	DC3	PNP	cable	XS508B1P A L2	XS108B3P A L2	XS512B1P A L2	XS112B3P A L2	XS512B1P A L2	XS112B3P A M12	XS112B3P A M12	
		connector	XS508B1P A M8	XS108 B3P A M8	XS512B1P A M12	XS112B3P A M12	XS512B1P A M12	XS112B3N A L2	XS112B3N A L2	XS112B3N A M12	
	NPN	cable	XS508B1N A L2	XS108B3N A L2	XS512B1N A L2	XS112B3N A L2	XS512B1N A M12	XS112B3N A M12	XS512B1N A M12	XS112B3N A M12	
		connector	XS508B1N A M8	XS108B3N A M8	XS512B1N A M12	XS112B3N A M12	XS512B1N A M12	XS112B3N A M12	XS512B1N A M12	XS112B3N A M12	
DC2	cable	XS508B3C A L2	XS608B3C A L2	XS512B3C A L2	XS612B3D A L2	XS512B3C A L2	XS612B3D A L2	XS512B3C A M12	XS612B3D A M12	XS612B3D A M12	
	connector	XS508B3C A L01M12	XS608B3C A L01M12	XS512B3C A M12	XS612B3D A M12	XS512B3C A M12	XS612B3D A M12	XS512B3C A M12	XS612B3D A M12	XS612B3D A M12	
Long	DC3	PNP	cable	XS508BLP A L2	XS608B1P A L2	XS512BLP A L2	XS612B1P A L2	XS512BLP A M12	XS612B1P A M12	XS512BLP A M12	XS612B1P A M12
		connector	XS508BLP A M12	XS608B1P A M12	XS512BLP A M12	XS612B1P A M12	XS512BLP A M12	XS612B1P A M12	XS512BLP A M12	XS612B1P A M12	
	NPN	cable	XS508BLN A L2	XS608B1N A L2	XS512BLN A L2	XS612B1N A L2	XS512BLN A M12	XS612B1N A M12	XS512BLN A M12	XS612B1N A M12	
		connector	XS508BLN A M12	XS608B1N A M12	XS512BLN A M12	XS612B1N A M12	XS512BLN A M12	XS612B1N A M12	XS512BLN A M12	XS612B1N A M12	
DC2	cable	XS508B1D A L2	XS608B1D A L2	XS512B1D A L2	XS612B1D A L2	XS512B1D A M12	XS612B1D A M12	XS512B1D A M12	XS612B1D A M12		
	connector	XS508B1D A M12	XS608B1D A M12	XS512B1D A M12	XS612B1D A M12	XS512B1D A M12	XS612B1D A M12	XS512B1D A M12	XS612B1D A M12		
AC/DC	cable					XS512B1M A L2	XS612B1M A L2	XS512B1M A L2	XS612B1M A L2		
	connector					XS512B1M A U20	XS612B1M A U20	XS512B1M A U20	XS612B1M A U20		
Output function	NO			A				A		A	
	NC			B				B		B	



Flush mountable			8x22x8 mm		15x32x8 mm		26x26x13 mm		40x40x15 mm		
Sensing distance			2.5 mm		5 mm		10 mm		15 mm		
DC3	PNP	cable	XS7J1A1P A L2	XS7F1A1P A L2	XS7E1A1P A L2	XS7C1A1P A L2	XS7E1A1P A L2	XS7C1A1P A L2	XS7E1A1P A L2	XS7C1A1P A L2	
		connector	XS7J1A1P A L01M8	XS7F1A1P A L01M8	XS7E1A1P A M8	XS7C1A1P A M8	XS7E1A1P A M8	XS7C1A1P A M8	XS7E1A1P A M8	XS7C1A1P A M8	
	NPN	cable	XS7J1A1N A L2	XS7F1A1N A L2	XS7E1A1N A L2	XS7C1A1N A L2	XS7E1A1N A M12	XS7C1A1N A M12	XS7E1A1N A M12	XS7C1A1N A M12	
		connector	XS7J1A1N A L01M8	XS7F1A1N A L01M8	XS7E1A1N A M8	XS7C1A1N A M8	XS7E1A1N A M12	XS7C1A1N A M12	XS7E1A1N A M12	XS7C1A1N A M12	
DC2	cable	XS7J1A1D A L2	XS7F1A1D A L2	XS7E1A1D A L2	XS7C1A1D A L2	XS7E1A1D A L2	XS7C1A1D A L2	XS7E1A1D A M8	XS7C1A1D A M8		
	connector	XS7J1A1D A L01M8	XS7F1A1D A L01M8	XS7E1A1D A M8	XS7C1A1D A M8	XS7E1A1D A M8	XS7C1A1D A M8	XS7E1A1D A M8	XS7C1A1D A M8		
Flush adaptable mountable	DC3	PNP	cable					XS8E1A1P A L2	XS8C1A1P A L2	XS8E1A1P A L2	XS8C1A1P A L2
		connector					XS8E1A1P A M8	XS8C1A1P A M8	XS8E1A1P A M8	XS8C1A1P A M8	
	NPN	cable					XS8E1A1N A L2	XS8C1A1N A L2	XS8E1A1N A L2	XS8C1A1N A L2	
		connector					XS8E1A1N A M8	XS8C1A1N A M8	XS8E1A1N A M8	XS8C1A1N A M8	
AC/DC	cable					XS8E1A1M A L2	XS8C1A1M A L2	XS8E1A1M A L2	XS8C1A1M A L2		
	connector					XS8E1A1M A L01U20	XS8C1A1M A L01U20	XS8E1A1M A L01U20	XS8C1A1M A L01U20		
Output function	NO			A				A		A	
	NC			B				B		B	

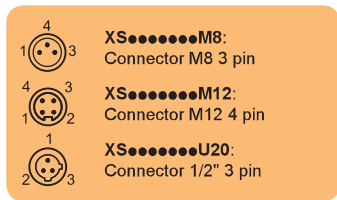

Cabling XS

M8	PUR pre wired connectors (female)*		
	straight	elbowed	
3 pin	2 m	XZCP0566L2	XZCP0666L2
	5 m	XZCP0566L5	XZCP0666L5
	10 m	XZCP0566L10	XZCP0666L10
1/2"	3 pin	XZCP1865L5	XZCP1965L5

*For a PVC cable, add the letter V after the P. Example: XZCPxxxxx become XZCPVxxxxx

Inductives: OsiSense XS

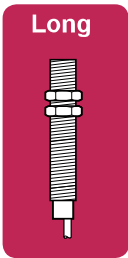
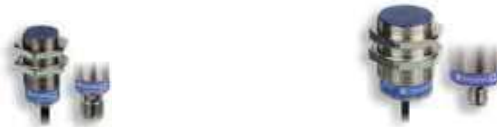

			M18		M30	
			5 mm	8 mm	10 mm	15 mm
DC3	PNP	cable	XS518B1P A L2	XS118B3P A L2	XS530B1P A L2	XS130B3P A L2
		connector	XS518B1P A M12	XS118B3P A M12	XS530B1P A M12	XS130B3P A M12
	NPN	cable	XS518B1N A L2	XS118B3N A L2	XS530B1N A L2	XS130B3N A L2
		connector	XS518B1N A M12	XS118B3N A M12	XS530B1N A M12	XS130B3N A M12
DC2	cable	XS518BSD A L2	XS618B3D A L2	XS530BSD A L2	XS630B3D A L2	
	connector	XS518BSD A M12	XS618B3D A M12	XS530BSD A M12	XS630B3D A M12	
DC3	PNP	cable	XS518BLP A L2	XS618B1P A L2	XS530BLP A L2	XS630B1P A L2
		connector	XS518BLP A M12	XS618B1P A M12	XS530BLP A M12	XS630B1P A M12
	NPN	cable	XS518BLN A L2	XS618B1N A L2	XS530BLN A L2	XS630B1N A L2
		connector	XS518BLN A M12	XS618B1N A M12	XS530BLN A M12	XS630B1N A M12
DC2	cable	XS518B1D A L2	XS618B1D A L2	XS530B1D A L2	XS630B1D A L2	
	connector	XS518B1D A M12	XS618B1D A M12	XS530B1D A M12	XS630B1D A M12	
AC/DC	cable	XS518B1M A L2	XS618B1M A L2	XS530B1M A L2	XS630B1M A L2	
	connector	XS518B1M A U20	XS618B1M A U20	XS530B1M A U20	XS630B1M A U20	
Output function	NO		A	A	A	A
	NC		B	B	B	B

Accessories



M8	XSZB108
M12	XSZB112
M18	XSZB118
M30	XSZB130

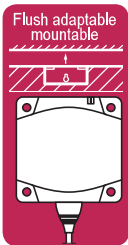
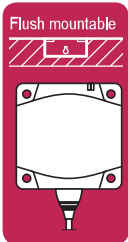

			80x80x26 mm	
			40 mm	
DC3	PNP	cable	XS7D1A1P A L2	
		connector	XS7D1A1P A M12	
	NPN	cable	XS7D1A1N A L2	
		connector	XS7D1A1N A M12	
DC2	cable	XS7D1A1D A L2		
	connector	XS7D1A1D A M12		
AC/DC	cable	XS8D1A1M A L2		
		XS8D1A1M A U20		
	connector	XS8D1A1M A L2		
		XS8D1A1M A U20		
Output function	NO		A	
	NC		B	

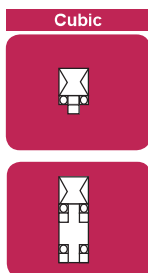

			40x40x117 mm	
			20 mm	40 mm
DC4	PNP	NO+NC	XS8C2A1PCM12	XS8C2A4PCM12
		NO+NC	XS8C2A1NCM12	XS8C2A4NCM12
DC2	NPN	NO	XS8C2A1DAM12	XS8C2A4DAM12
		NO	XS8C2A1MAU20	XS8C2A4MAU20
DC4	PNP	NO+NC	XS8C4A1PCP20	XS8C4A4PCP20
		NO+NC	XS8C4A1NCP20	XS8C4A4NCP20
DC2	NPN	NO or NC	XS8C4A1DPP20	XS8C4A4DPP20
		NO or NC	XS8C4A1MPP20	XS8C4A4MPP20

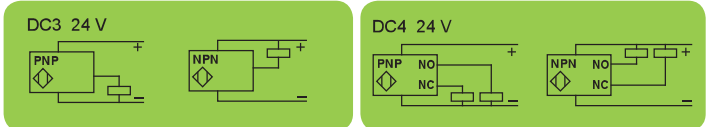

Accessories



For 26x26	XSZBE00	XSZBE90
For 40x40	XSZBC00	XSZBC90

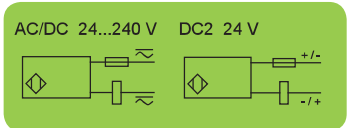

Cabling XS

		PUR pre wired connectors (female)*		
M12		straight	elbowed	elbowed PNP LED
4 pin	2 m	XZCP1141L2	XZCP1241L2	XZCP1340L2
	5 m	XZCP1141L5	XZCP1241L5	XZCP1340L5
	10 m	XZCP1141L10	XZCP1241L10	XZCP1340L10

		Connectors (female)	
M12		straight	elbowed
4 pin	(1)	XZCC12FDM40B	XZCC12FCM40B
	(2)	XZCC12FDP40B	XZCC12FCP40B

(1) Steel ring (2) Plastic ring

*For a PVC cable add the letter V after the P. Example: XZCPxxxxx become XZCPVxxxxx

Photo-electrics: OsiSense XU

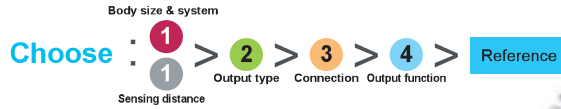

		Sensing distance				M18 metal	M18 plastic	Miniature	
Diffuse 	0,6 m	DC3	PNP	cable	XUB5BP A NL2	XUB5AP A NL2	1 m	XUM5AP C NL2	
				connector 4P	XUB5BP A NM12	XUB5AP A NM12		XUM5AP C NM8	
	0,1 m	DC3	PNP	cable	XUB5BN A NL2	XUB5AN A NL2		XUM5AN C NL2	
				connector 4P	XUB5BN A NM12	XUB5AN A NM12		XUM5AN C NM8	
			NPN	cable	XUB4BP A NL2	XUB4AP A NL2			
				connector 4P	XUB4BP A NM12	XUB4AP A NM12			
Polarized Reflex 	2 m	DC3	PNP	cable	XUB9BP A NL2	XUB9AP A NL2	5 m	XUM9AP C NL2	
				connector 4P	XUB9BP A NM12	XUB9AP A NM12		XUM9AP C NM8	
	NPN	cable	XUB9BN A NL2	XUB9AN A NL2	XUM9AN C NL2				
		connector 4P	XUB9BN A NM12	XUB9AN A NM12	XUM9AN C NM8				
		Accessory: Reflector		XUZC50	XUZC50	XUZC50			
Reflex 	4 m	DC3	PNP	cable	XUB1BP A NL2	XUB1AP A NL2			
				connector 4P	XUB1BP A NM12	XUB1AP A NM12			
	NPN	cable	XUB1BN A NL2	XUB1AN A NL2					
		connector 4P	XUB1BN A NM12	XUB1AN A NM12					
		Accessory: Reflector		XUZC50	XUZC50				
Thru-beam 	15 m	DC3	PNP	cable	XUB2BP A NL2R	XUB2AP A NL2R	15 m	XUM2AP C NL2R	
				connector 4P	XUB2BP A NM12R	XUB2AP A NM12R		XUM2AP C NM8R	
	NPN	cable	XUB2BN A NL2R	XUB2AN A NL2R	XUM2AN C NL2R				
		connector 4P	XUB2BN A NM12R	XUB2AN A NM12R	XUM2AN C NM8R				
		Accessory: Transmitter		cable	XUB2BKSNL2T	XUB2AKSNL2T		XUM2AK C NL2T	
		connector 4P	XUB2BKSNM12T	XUB2AKSNM12T	XUM2AK C NM8T				
	Output function		NO		A	A		NO or NC	C
			NC		B	B			

Multimode 		DC3	PNP	cable	XUB0BPSNL2	XUB0APSNL2	XUM0APSNL2	
				connector 4P	XUB0BPSNM12	XUB0APSNM12	XUM0APSNM12	
			NPN	cable	XUB0BNSNL2	XUB0ANSNL2	XUM0ANSNL2	
				connector 4P	XUB0BNSNM12	XUB0ANSNM12	XUM0ANSNM12	
		Sensing distance			Background Sup: 0.12 m	Diffuse: 0.3 m	BGS: 0.1 m D: 0.4 m	
		Output function		NO or NC	Polarized reflex: 3 m	Thru-beam: 20 m	P: 3 m TB: 10 m	
Accessory: Transmitter		DC		cable	XUB0BKSNL2T	XUB0AKSNL2T	XUM0AKSNL2T	
				connector 4P	XUB0BKSNM12T	XUB0AKSNM12T	XUM0AKSNM12T	

Reflectors

XUZC24 XUZC80 XUZC50 XUZC100

3D fixings with ball joint

Bracket with ball joint for sensors and reflector XUZC50

Protective housing with ball joint

M12 rod for ball joint

Fixing support for M12 rod

XUB XUZB2003
XUMO XUZM2003
XUK... XUZK2003
XUX... XUZX2003

XUZK2004 XUZK2004
XUZ2001 XUZ2003

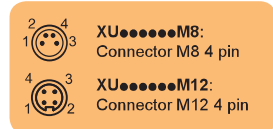

Cabling XU

PUR pre wired connectors (female)*

M8		straight	elbowed
4 pin	2 m	XZCP0941L2	XZCP1041L2
	5 m	XZCP0941L5	XZCP1041L5
	10 m	XZCP0941L10	XZCP1041L10

*For a PVC cable, add the letter V after the P. Example: XZCPxxxxx become XZCPVxxxxx

Photo-electrics: OsiSense XU



		Sensing distance			Compact 50x50 mm		Compact 92x71 mm				
	1 m	DC3	PNP	cable	XUK5AP A NL2	2.1 m	DC3	PNP	terminals	XUX5AP A NT16	
				connector 4P	XUK5AP A NM12				connector 4P	XUX5AP A NM12	
				NPN	cable				XUK5AN A NL2	terminals	XUX5AN A NT16
					connector 4P				XUK5AN A NM12	connector 4P	XUX5AN A NM12
				AC/DC	Relay				cable	XUK5ARCNL2	AC/DC
Output function		NO		A		NO		A			
		NC		B		NC		B			
	5 m	DC3	PNP	cable	XUK9AP A NL2	11 m	DC3	PNP	terminals	XUX9AP A NT16	
				connector 4P	XUK9AP A NM12				connector 4P	XUX9AP A NM12	
				NPN	cable				XUK9AN A NL2	terminals	XUX9AN A NT16
					connector 4P				XUK9AN A NM12	connector 4P	XUX9AN A NM12
				AC/DC	Relay				cable	XUK9ARCNL2	AC/DC
Accessory: Reflector				XUZC50				XUZC50			
	7 m	DC3	PNP	cable	XUK1AP A NL2	14 m	DC3	PNP	terminals	XUX1AP A NT16	
				connector 4P	XUK1AP A NM12				connector 4P	XUX1AP A NM12	
				NPN	cable				XUK1AN A NL2	terminals	XUX1AN A NT16
					connector 4P				XUK1AN A NM12	connector 4P	XUX1AN A NM12
				AC/DC	Relay				cable	XUK1ARCNL2	AC/DC
Accessory: Reflector				XUZC50				XUZC50			
	30 m	DC3	PNP	cable	XUK2AP A NL2R	40 m	DC3	PNP	terminals	XUX2AP A NT16R	
				connector 4P	XUK2AP A NM12R				connector 4P	XUX2AP A NM12R	
				NPN	cable				XUK2AN A NL2R	terminals	XUX2AN A NT16R
					connector 4P				XUK2AN A NM12R	connector 4P	XUX2AN A NM12R
				AC/DC	Relay				cable	XUK2ARCNL2R	AC/DC
Accessory: Transmitter				XUK2AKSNL2T				XUX0AKSAT16T			
				XUK2AKSNM12T				XUX0AKSAM12T			
				XUK2ARCNL2T				XUX0ARCTT16T			

Multimode		DC3 PNP/NPN		cable		XUK0AKSAL2		DC3 PNP/NPN		terminals		XUX0AKSAT16	
	Background suppression: 0.28 m	DC	Relay	cable	XUK0AKSAL2T	Background Suppression: 1.3 m	DC	Relay	terminals	XUX0AKSAT16T			
				connector 4P	XUK0AKSAM12T				connector 4P	XUX0AKSAM12T			
				AC/DC	cable				XUK0ARCTL2T	AC/DC	terminals	XUX0ARCTT16T	
Background Suppression: 0.28 m		Diffuse: 0.8 m				Background Suppression: 1.3 m		Diffuse: 2 m					
Polarized reflex: 4 m		Thru-beam: 30 m				Polarized reflex: 11 m		Thru-beam: 40 m					
Accessory: Transmitter				XUK0AKSAL2T				XUX0AKSAT16T				XUX0AKSAM12T	
				XUK0AKSAM12T				XUX0AKSAM12T				XUX0ARCTT16T	
				XUK0ARCTL2T				XUX0ARCTT16T					

Other fixings

Single bracket

	standard	with ball joint
XUB	XUZA118 (stainless steel)	XUZA218 (plastic)
XUM	XUZAM02	-
XUK	XUZA51	-
XUX	XUZX2000	-

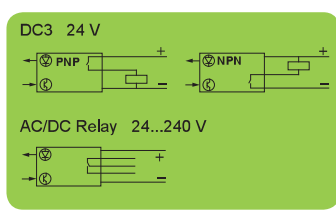

PUR pre wired connectors (female)*				Connectors (female)				
M12	4 pin	straight	elbowed	straight	elbowed			
		2 m	XZCP1141L2	XZCP1241L2	XZCP1340L2	4 pin (1)	XZCC12FDM40B	XZCC12FCM40B
		5 m	XZCP1141L5	XZCP1241L5	XZCP1340L5	4 pin (2)	XZCC12FDP40B	XZCC12FCP40B
	10 m	XZCP1141L10	XZCP1241L10	XZCP1340L10	(1) Steel ring (2) Plastic ring			

*For a PVC cable, add the letter V after the P. Example: XZCPxxxxx become XZCPVxxxxx

Ultrasonic: OsiSense XX

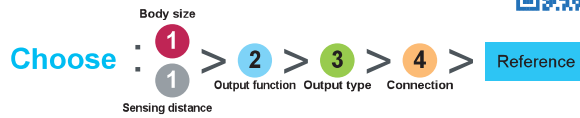

	M12		M18		M18 metal	M30		M30 stainless
Sensing distance	0.05 m	0.1 m	0.15 m	0.5 m Adjust.	0.05 m fixed	1 m Adjust.	8 m Adjust.	1 m Adjust.
Connectors/Cables	M8 4 pin	M8 3 pin	M12 4 pin	M12 4 pin	M12 4 pin	M12 4 pin	M12 4 pin	M12 4 pin
NO	DC4 PNP/NPN	XX512A1KAM8	XX518A1KAM12			XX630A1KAM12		
	DC3 PNP	XX512A2PAM8	XX518A3PAM12 (1)	XXV18B1PAM12		XX6V3A1PAM12 (1)		
NO+NC	DC4 PNP	XX512A2NAM8	XX518A3NAM12 (1)			XX6V3A1NAM12 (1)		
	NPN							
Analogue	DC4 PNP					XX630A1PCM12	XX630A3PCM12	XX630S1PCM12
	NPN					XX630A1NCM12	XX630A3NCM12	XX630S1NCM12
	4...20 mA		XX918A3C2M12 (1)			XX9V3A1C2M12 (1)	XX930A3A2M12	XX930S1A2M12
0...10 V		XX918A3F1M12 (1)			XX9V3A1F1M12 (1)	XX930A3A1M12	XX930S1A1M12	

(1) Adjustable with XXZPB100

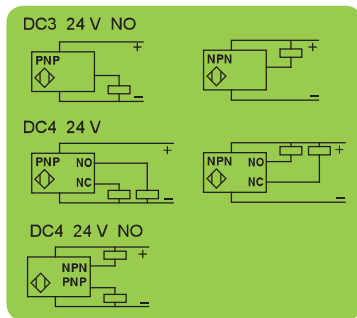

	Flat 7.6x19x33		Flat 16x30x74	Flat 60x30x18 + M18	
Sensing distance	0.1 m		0.25 m	0.5 m Adjust.	
Connectors	M12 4 pin		M12 4 pin	M12 4 pin	M12 4 pin
NO	DC3 PNP	XX7F1A2PAL01M12	XX7K1A2PAM12		XX7V1A1PAM12 (1)
	NPN	XX7F1A2NAL01M12	XX7K1A2NAM12		XX7V1A1NAM12 (1)
Analogue	4...20 mA			XX9V1A1C2M12 (1)	
	0...10 V			XX9V1A1F1M12 (1)	

(1) Adjustable with XXZPB100

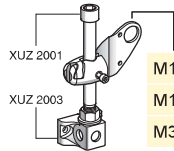

M12	XUZZ2012
M18	XUZZ2003
M30	XUZZ2030

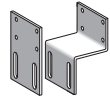

For XX7K	
Flat	XXZ3074F
Cranked	XXZ3074S



M12	XXZ12
M18	XUZA118
M30	XXZ30
XX7F	XXZ1933

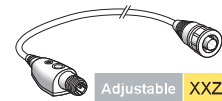

Adjustable XXZPB100

Forks: OsiSense XUV

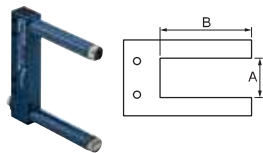

		A: 50 mm / B: 60 mm		A: 80 mm / B: 60 mm		A: 120 mm / B: 120 mm		A: 180 mm / B: 120 mm	
DC3	PNP	M8 3 pin	XUVR0605P A NM8	XUVR0608P A NM8	XUVR1212P A NM8	XUVR1218P A NM8			
	NPN	M8 3 pin	XUVR0605N A NM8	XUVR0608N A NM8	XUVR1212N A NM8	XUVR1218N A NM8			
Output function	NO		A		A		A		A
	NC		B		B		B		B

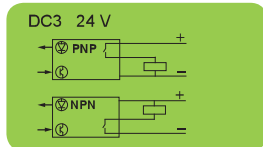

Cabling XX & XUV

		PUR pre wired connectors (female)*			Connectors (female)		
M8		straight	elbowed	elbowed PNP LED	M12	straight	elbowed
3 pin	2 m	XZCP0566L2	XZCP0666L2		(1)	4 pin XZCC12FDM40B	XZCC12FCM40B
	5 m	XZCP0566L5	XZCP0666L5		(2)	4 pin XZCC12FDP40B	XZCC12FCP40B
	10 m	XZCP0566L10	XZCP0666L10		(1) Steel ring (2) Plastic ring		
4 pin	2 m	XZCP0941L2	XZCP1041L2				
	5 m	XZCP0941L5	XZCP1041L5				
	10 m	XZCP0941L10	XZCP1041L10				
M12		straight	elbowed	elbowed PNP LED	M12	straight	elbowed
4 pin	2 m	XZCP1141L2	XZCP1241L2	XZCP1340L2		4 pin XZCC12MDM40B	XZCC12MCM40B
	5 m	XZCP1141L5	XZCP1241L5	XZCP1340L5		5 pin XZCC12MDM50B	XZCC12MCM50B
	10 m	XZCP1141L10	XZCP1241L10	XZCP1340L10			

*For a PVC cable, add the letter V after the P. Example: XZCPxxxxxx become XZCPVxxxxxx

For more information on Detection components, please connect to website: www.tesensors.com

Compliance with standard IEC 60364-4-4

- Double insulation via an integrated isolation transformer
- Limiting the output voltage to less than 60 V in the event of an internal fault
- Integrated overload, short-circuit, overvoltage and undervoltage protection
- A high degree of output voltage stability, accuracy 3%
- Remote diagnostics via a relay contact for the Universal range
- Integrated anti-harmonics filter

Tương thích với tiêu chuẩn IEC 60364-4-41

- Cách ly điện kép thông qua biến áp cách ly.
- Điện áp ra không quá 60 V trong trường hợp sự cố.
- Tích hợp bảo vệ quá tải, ngắn mạch, quá áp và thấp áp.
- Ổn định điện áp đầu ra, sai lệch 3%
- Giám sát từ xa thông qua relay đối với dòng Universal
- Tích hợp bộ lọc sóng hài

Unit price (incl.VAT) in VND

Phaseo Modular range, compatible with the Zelio Logic range and small Twido

Single phase, input 100-240Vac



Description	Reference	Unit Price
Output 24Vdc, 0.3A	ABL8MEM24003	1,881,000
Output 24Vdc, 0.6A	ABL8MEM24006	2,112,000
Output 24Vdc, 1.2A	ABL8MEM24012	3,014,000
Output 24Vdc, 2.5A	ABL7RM24025	4,807,000
Output 5 Vdc, 4 A	ABL8MEM05040	3,014,000
Output 12Vdc, 2.0A	ABL8MEM12020	3,014,000

Phaseo Optimum range, compatible with Twido and the smallest Modicon M340 range

Single phase, input 100-240Vac



Output 24Vdc, 3.0 A	ABL8REM24030	4,136,000
Output 24Vdc, 5.0 A	ABL8REM24050	6,413,000
Output 12Vdc, 5.0A	ABL7RP1205	12,023,000
Output 48 Vdc,2.5A	ABL7RP4803	12,023,000

Phaseo Universal range, compatible with the Modicon M340, Premium and Quantum ranges

1 phase, input 100-120Vac / 200-500Vac, output 24Vdc, 3.0A	ABL8RPS24030	5,610,000
1 phase, input 100-120Vac / 200-500Vac, output 24Vdc, 5.0A	ABL8RPS24050	6,809,000
1 phase, input 100-120Vac / 200-500Vac, output 24Vdc, 10.0A	ABL8RPS24100	8,019,000
1 phase, input 100-120Vac / 200-500Vac, output 24Vdc, 20.0A	ABL8RPM24200	15,235,000
3 phase, input 380-500Vac, output 24Vdc, 20.0A	ABL8WPS24200	13,222,000
3 phase, input 380-500Vac, output 24Vdc, 40.0A	ABL8WPS24400	22,451,000

Function modules - Solutions to microbreaks and network power outages



Buffer Module, 24V, 40 A, Solutions to microbreaks	ABL8BUF24400	11,220,000
Battery control module, 24V, 20 A	ABL8BBU24200	11,264,000
Battery control module, 24V, 40 A	ABL8BBU24400	12,375,000
Battery module, 24V, 3.2 Ah	ABL8BPK24A03	7,920,000
Battery module, 24 V, 7 Ah	ABL8BPK24A07	8,910,000
Battery module, 24 V, 12 Ah	ABL8BPK24A12	17,644,000
Redundancy Module, 24 V, 40 A	ABL8RED24400	7,216,000

Phaseo Dedicated range, suitable for standard commercial machines

Single phase, input 100 - 240V



Output 12V, 5.0 A	ABL1REM12050	1,595,000
Output 24V, 2.5 A	ABL1REM24025 (*)	1,441,000
Output 24V, 4.2 A	ABL1REM24042 (*)	2,431,000
Output 24V, 6.2 A	ABL1REM24062 (*)	3,168,000
Output 24V, 10 A	ABL1REM24100 (*)	5,610,000
Output 12 V, 8.3 A, with filter	ABL1RPM12083	2,772,000
Output 24V, 4.2 A, with filter	ABL1RPM24042	3,223,000
Output 24V, 6.2 A, with filter	ABL1RPM24062	3,795,000
Output 24V, 10 A, with filter	ABL1RPM24100	4,961,000

Zelio® Logic Programmable Smart Relay

Zelio Logic is a programmable relay. Zelio Logic's small size and ease of programming provides a modern and smart alternative to traditional control board with relays, timers, and counters.

Zelio Logic là relay lập trình được. Với kích thước nhỏ gọn và khả năng lập trình dễ dàng, Zelio Logic cung cấp giải pháp hiện đại và thông minh thay thế các bảng điều khiển cổ điển làm bằng relay, bộ đếm và bộ định thời

Unit price (incl.VAT) in VND



Zelio Logic – Smart Relays Compact - Without display

Description	Reference	Unit Price
10 I/O, 120-240Vac, 6 inputs, 4 relay outputs, without clock	SR2D101FU	2,783,000
20 I/O, 120-240Vac, 12 inputs, 8 relay outputs, without clock	SR2D201FU	4,290,000
12 I/O, 24Vdc, 8 inputs (4 analogs), 4 relay outputs, with clock	SR2E121BD	2,860,000
12 I/O, 120-240Vac, 8 inputs, 4 relay outputs, with clock	SR2E121FU	2,959,000
20 I/O, 24Vdc, 12 inputs(including analog), 8 relay outputs, with clock	SR2E201BD	4,290,000
20 I/O, 120-240Vac, 12 inputs, 8 relay outputs, with clock	SR2E201FU	4,400,000



Zelio Logic – Smart Relays Compact (non-expandable) – With Display

Description	Reference	Unit Price
10 I/O, 24Vdc, 6 inputs, 4 relay outputs, without clock	SR2A101BD	3,102,000
10 I/O, 120-240Vac, 6 inputs, 4 relay outputs, without clock	SR2A101FU	3,190,000
20 I/O, 120-240Vac, 12 inputs, 8 relay outputs, without clock	SR2A201FU	4,763,000
12 I/O, 24Vdc, 8 inputs (including 4 analog), 4 relay outputs, with clock	SR2B121BD	4,015,000
12 I/O, 120-240Vac, 8 inputs, 4 relay outputs, with clock	SR2B121FU	4,092,000
12 I/O, 12Vdc, 8 inputs (including 4 analog), 4 relay outputs, with clock	SR2B121JD	3,938,000
20 I/O, 120-240Vac, 12 inputs, 8 relay outputs, with clock	SR2B201FU	5,940,000
20 I/O, 24Vdc, 12 inputs(including analog), 8 transistor outputs, with clock	SR2B202BD	4,851,000

Zelio Logic – Smart Relays Modular – With Display

Description	Reference	Unit Price
10 I/O, 24Vac, 6 inputs, 4 relay outputs, with clock	SR3B101B	3,432,000
10 I/O, 24Vdc, 6 inputs (including 4 analog), 4 relay outputs, with clock	SR3B101BD	4,367,000
10 I/O, 120-240Vac, 6 inputs, 4 relay outputs, with clock	SR3B101FU	3,542,000
10 I/O, 24Vdc, 6 inputs (including 4 analog), 4 transistor outputs, with clock	SR3B102BD	4,059,000
26 I/O, 24Vac, 16 inputs, 10 relay outputs, with clock	SR3B261B	6,237,000
26 I/O, 24Vdc, 16 inputs (including 6 analog), 10 relay outputs, with clock	SR3B261BD	6,512,000
26 I/O, 100-240Vac, 16 inputs, 10 relay outputs, with clock	SR3B261FU	6,149,000
26 I/O, 12Vdc, 16 inputs (including 6 analog), 10 relay outputs, with clock	SR3B261JD	6,237,000
26 I/O, 24Vdc, 16 inputs (including 6 analog), 10 transistor outputs, with clock	SR3B262BD	5,742,000

Zelio Logic SR3 Digital & Analog Expansion I/O Modules

Description	Reference	Unit Price
10 pt Digital, 24Vdc, 6 inputs, 4 relay outputs	SR3XT101BD	1,683,000
10 pt Digital, 120-240Vac, 6 inputs, 4 relay outputs	SR3XT101FU	1,683,000
10 pt Digital, 12Vdc, 6 inputs, 4 relay outputs	SR3XT101JD	1,716,000
14 pt Digital, 24Vdc, 8 inputs, 6 relay outputs	SR3XT141BD	2,497,000
14 pt Digital, 120-240Vac, 8 inputs, 6 relay outputs	SR3XT141FU	2,497,000
14 pt Analog, 12Vdc, 8 inputs, 6 relay outputs	SR3XT43BD	3,597,000
6 pt Digital, 24Vac, 4 inputs, 2 relay outputs	SR3XT61B	1,298,000
6 pt Digital, 24Vdc, 4 inputs, 2 relay outputs	SR3XT61BD	1,276,000
6 pt Digital, 120-240Vac, 4 inputs, 2 relay outputs	SR3XT61FU	1,276,000

Zelio Logic - Communications Modules

Description	Reference	Unit Price
SR3 ModBus Slave Communications Module, with 24 VDC version only	SR3MBU01BD	4,224,000
Zelio Logic Communication Module	SR2COM01	4,257,000

Zelio Logic - Programming cable and software

Description	Reference	Unit Price
Programming cable for Zelio, RS232	SR2CBL01	2,299,000
Programming cable for Zelio, USB port	SR2USB01	3,058,000
Zelio Soft, programming software for Zelio		Free of charge

Maximize your business and machine performance with MachineStruxure

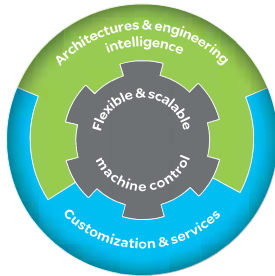

Machine builders like you are constantly looking for new ways to design and build more innovative machines in less time and at lower cost. MachineStruxure™ can help.

The NEXT generation of MachineStruxure is a complete machine automation solution that provides flexible and scalable machine control, ready-to-use architectures, efficient engineering solutions, and comprehensive customization and engineering support services. It can help you meet your challenges for improved efficiency and greater productivity, as well as allow you to deliver higher added value to your customers throughout the entire machine life cycle.

Ready-to-use architectures and function blocks

Tested, Validated, and Documented Architectures (TVDAs) are just one of the ways we help you reduce design time. Whether your machines are simple or complex, Application Function Blocks (AFBs) make system design fast and easy.

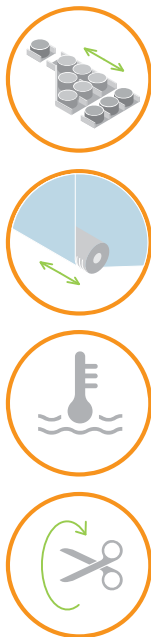

Application Function Blocks (AFB)

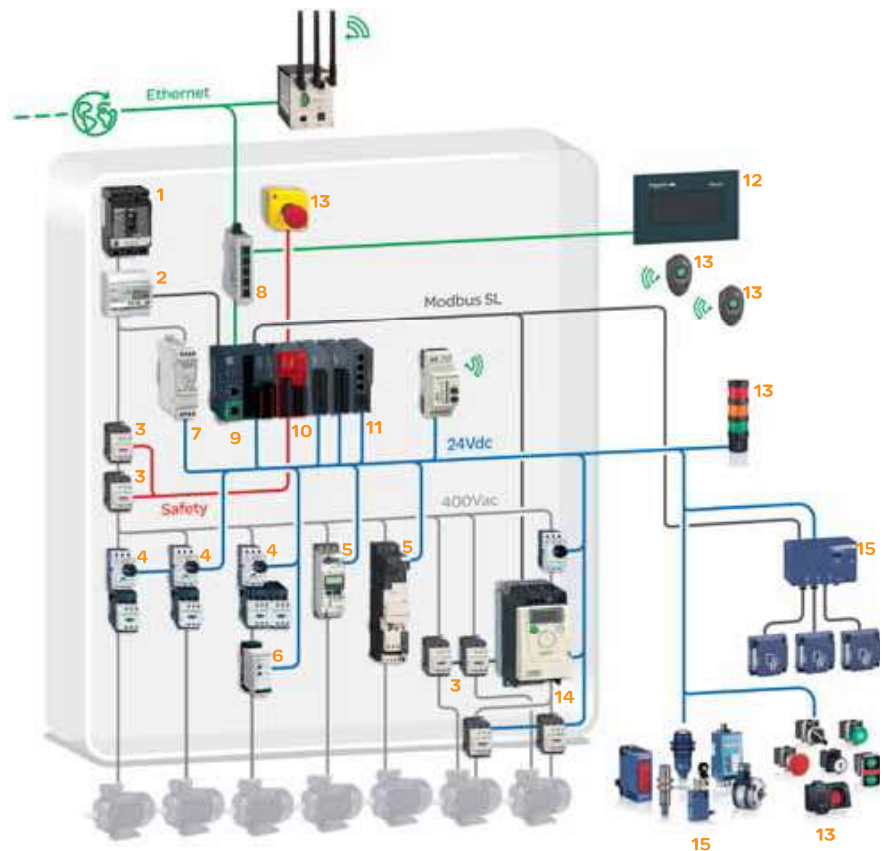

- | | |
|------------------------------------|--|
| 1 POWERPACT circuit breaker | 10 Modicon TM3 safety module, Modicon TM3 digital/analog I/O modules |
| 2 Energy meter Acti9 iEM310 iEM310 | 11 Modicon TM3 TeSys motor starter module |
| 3 TeSys D contactor | 12 Magelis display |
| 4 TeSys GV2P motor circuit-breaker | 13 Harmony signalling and control devices |
| 5 TeSys U starter-controller | 14 Altivar 312 variable speed drive |
| 6 Multi9 circuit-breaker C60N | 15 OsiSense: limit switches and inductive sensors |
| 7 Phaseo power supply 24 V --- | |
| 8 Ethernet switch (unmanaged) | |
| 9 Modicon M2xx logic controller | |

Programmable Logic Controller - Modicon M2xx

The Modicon M2xx logic controller offer best in class performance. Available also in book format, the modicon M2xx requires minimal installation and offers tremendous versatility.

PLC Modicon M2xx được thiết kế với hiệu năng cao, đáp ứng hầu hết các nhu cầu dạng trong lĩnh vực chế tạo máy. Bên cạnh đó, với dòng Book được thiết kế theo kiểu mô-dun nhỏ gọn, Modicon M2xx còn có khả năng tối ưu không gian lắp đặt.

Unit price (incl.VAT) in VND

Modicon M221 logic controller

Modicon M221 logic controller - Compact , 24Vdc power supply



Reference	Description	Number of logic I/O	Analog I/O	Ethernet CANopen	Serial links RJ45 Screw ter	Unit Price
TM221C16T	CONTROLLER M221-16IO TR.SOURCE COMPACT	9 input (4 HSC) 7 output (2 PTO)	2 input-0..10V	- -	1 -	7,216,000
TM221CE16T	CONTROLLER M221-16IO TR.SOURCE ETHERNET COMPACT	9 input (4 HSC) 7 output (2 PTO)	2 input-0..10V	1 -	1 -	7,414,000
TM221C24T	CONTROLLER M221-24IO TR.SOURCE COMPACT	14 input (4 HSC) 10 output (2 PTO)	2 input-0..10V	- -	1 -	7,832,000
TM221CE24T	CONTROLLER M221-24IO TR.SOURCE ETHERNET COMPACT	14 input (4 HSC) 10 output (2 PTO)	2 input-0..10V	1 -	1 -	8,701,000
TM221C40T	CONTROLLER M221-40IO TR.SOURCE COMPACT	24 input (4 HSC) 16 output (2 PTO)	2 input-0..10V	- -	1 -	10,450,000
TM221CE40T	CONTROLLER M221-40IO TR.SOURCE ETHERNET COMPACT	24 input (4 HSC) 16 output (2 PTO)	2 input-0..10V	1 -	1 -	11,319,000

Modicon M221 logic controller - Compact , 100-240Vac power supply

Reference	Description	Number of logic I/O	Analog I/O	Ethernet CANopen	Serial links RJ45 Screw ter	Unit Price
TM221C16R	CONTROLLER M221-16IO RELAY COMPACT	9 input (4 HSC) 7 output	2 input-0..10V	- -	1 -	7,117,000
TM221CE16R	CONTROLLER M221-16IO RELAY ETHERNET COMPACT	9 input (4 HSC) 7 output	2 input-0..10V	1 -	1 -	7,326,000
TM221C24R	CONTROLLER M221-24IO RELAY COMPACT	24 input (4 HSC) 10 output	2 input-0..10V	- -	1 -	7,766,000
TM221CE24R	CONTROLLER M221-24IO RELAY ETHERNET COMPACT	24 input (4 HSC) 10 output	2 input-0..10V	1 -	1 -	8,624,000
TM221C40R	CONTROLLER M221-40IO RELAY COMPACT	24 input (4 HSC) 16 output	2 input-0..10V	- -	1 -	10,340,000
TM221CE40R	CONTROLLER M221-40IO RELAY ETHERNET COMPACT	24 input (4 HSC) 16 output	2 input-0..10V	1 -	1 -	11,220,000

Modicon M221 logic controller - Modular , 24Vdc power supply



Reference	Description	Number of logic I/O	Analog I/O	Ethernet CANopen	Serial links RJ45 Screw ter	Unit Price
TM221M16T	CONTROLLER M221-24IO TR.SOURCE MODULAR	8 input (4 HSC) 8 output (2 PTO)	2 input-0..10V	- -	2 -	7,656,000
TM221M16TG	CONTROLLER M221-24IO TR.SOURCE SPRING MODULAR	8 input (4 HSC) 8 output (2 PTO)	2 input-0..10V	- -	2 -	7,656,000
TM221ME16T	CONTROLLER M221-24IO TR.SOURCE ETH MODULAR	8 input (4 HSC) 8 output (2 PTO)	2 input-0..10V	1 -	1 -	8,514,000
TM221ME16TG	CONTROLLER M221-24IO TR.SOURCE ETH SPRING MODULAR	8 input (4 HSC) 8 output (2 PTO)	2 input-0..10V	1 -	1 -	8,514,000

Programmable Logic Controller - Modicon M2xx

The Modicon M2xx logic controller offer best in class performance. Available also in book format, the modicon M2xx requires minimal installation and offers tremendous versatility.

PLC Modicon M2xx được thiết kế với hiệu năng cao, đáp ứng hầu hết các nhu cầu dạng trong lĩnh vực chế tạo máy. Bên cạnh đó, với dòng Book được thiết kế theo kiểu mô-dun nhỏ gọn, Modicon M2xx còn có khả năng tối ưu không gian lắp đặt.

Unit price (incl.VAT) in VND

Modicon M221 logic controller

Modicon M221 logic controller - Modular , 100-240Vac power supply

Reference	Description	Number of logic I/O	Analog I/O	Ethernet CANopen	Serial links RJ45 Screw ter	Unit Price
TM221M16R	CONTROLLER M221-16IO RELAY MODULAR	8 input (4 HSC) 8 output	2 input-0..10V	- -	2 -	7,656,000
TM221M16RG	CONTROLLER M221-16IO RELAY SPRING MODULAR	8 input (4 HSC) 8 output	2 input-0..10V	- -	2 -	7,656,000
TM221ME16R	CONTROLLER M221-16IO RELAY ETHERNET MODULAR	8 input (4 HSC) 8 output	2 input-0..10V	1 -	1 -	8,514,000
TM221ME16RG	CONTROLLER M221-16IO RELAY ETH SPRING MODULAR	8 input (4 HSC) 8 output	2 input-0..10V	1 -	1 -	8,514,000

Modicon M221 logic controller - Modular , 24Vdc power supply (connect via HE10 connector)

Reference	Description	Number of logic I/O	Analog I/O	Ethernet CANopen	Serial links RJ45 Screw ter	Unit Price
TM221M32TK(*)	CONTROLLER M221-32IO TR.SOURCE MODULAR	16 input (4 HSC) 16 output (2 PTO)	2 input-0..10V	- -	2 -	8,514,000
TM221ME32TK(*)	CONTROLLER M221-32IO TR.SOURCE ETH MODULAR	16 input (4 HSC) 16 output (2 PTO)	2 input-0..10V	1 -	1 -	9,361,000

Modicon M241 logic controller, 24Vdc power supply

Reference	Description	Number of logic I/O	Analog I/O	Ethernet CANopen	Serial links RJ45 Screw ter	Unit Price
TM241C24T	CONTROLLER M241-24IO TR.SOURCE	14 input (8 HSC) 10 output (4 PTO)	-	- -	1 1	12,969,000
TM241CE24T	CONTROLLER M241-24IO TR.SOURCE ETHERNET	14 input (8 HSC) 10 output (4 PTO)	-	1 -	1 1	13,255,000
TM241CEC24T	CONTROLLER M241-24IO TR.SOURCE ETH.CAN MASTER	14 input (8 HSC) 10 output (4 PTO)	-	1 1	1 1	16,489,000



Modicon M241 logic controller, 100-240Vac power supply

Reference	Description	Number of logic I/O	Analog I/O	Ethernet CANopen	Serial links RJ45 Screw ter	Unit Price
TM241C24R	CONTROLLER M241-24IO RELAY	14 input (8 HSC) 10 output (4 PTO)	-	- -	1 1	12,848,000
TM241CE24R	CONTROLLER M241-24IO RELAY ETHERNET	14 input (8 HSC) 10 output (4 PTO)	-	1 -	1 1	13,112,000
TM241CEC24R	CONTROLLER M241-24IO RELAY ETHERNET CAN MASTER	14 input (8 HSC) 10 output (4 PTO)	-	1 1	1 1	16,489,000

Modicon M251 logic controller

Modicon M251 logic controller, 24Vdc power supply

Reference	Description	Number of logic I/O	Analog I/O	Ethernet CANopen	Serial links RJ45 Screw ter	Unit Price
TM251MESE	CONTROLLER M251-2X ETHERNET	-	-	3	1 -	12,155,000



Programmable Logic Controller - Modicon M2xx

The Modicon M2xx logic controller offer best in class performance. Available also in book format, the modicon M2xx requires minimal installation and offers tremendous versatility.

PLC Modicon M2xx được thiết kế với hiệu năng cao, đáp ứng hầu hết các nhu cầu dạng trong lĩnh vực chế tạo máy. Bên cạnh đó, với dòng Book được thiết kế theo kiểu mô-dun nhỏ gọn, Modicon M2xx còn có khả năng tối ưu không gian lắp đặt.

Unit price (incl.VAT) in VND

I/O Digital Module

Modicon M2xx

Reference	Description	Type of channels	Analog I/O	IO type	Cable connection	Unit Price
TM3DI8	MODULE TM3-8 INPUTS	8 inputs	-	Sink/source	Screw	1,870,000
TM3DI8G	MODULE TM3-8 INPUTS SPRING	8 inputs	-	Sink/source	Spring	1,870,000
TM3DI16	MODULE TM3-16 INPUTS	16 inputs	-	Sink/source	Screw	2,662,000
TM3DI16G	MODULE TM3-16 INPUTS SPRING	16 inputs	-	Sink/source	Spring	2,662,000
TM3DI16K(*)	MODULE TM3-16 INPUTS HE10	16 inputs	-	Sink/source	HE 10	2,134,000
TM3DI32K(*)	MODULE TM3-32 INPUTS HE10	32 inputs	-	Sink/source	HE 10	3,718,000
TM3DQ8R	MODULE TM3-8 OUTPUTS RELAYS	8 outputs	-	Relay	Screw	2,134,000
TM3DQ8RG	MODULE TM3-8 OUTPUTS RELAYS SPRING	8 outputs	-	Relay	Spring	2,134,000
TM3DQ16R	MODULE TM3-16 OUTPUTS RELAYS	16 outputs	-	Relay	Screw	2,937,000
TM3DQ16RG	MODULE TM3-16 OUTPUTS RELAYS SPRING	16 outputs	-	Relay	Spring	2,937,000
TM3DQ8T	MODULE TM3-8 OUTPUTS TR.SOURCE	8 outputs	-	Source	Screw	2,046,000
TM3DQ8TG	MODULE TM3-8 OUTPUTS TR.SOURCE SPRING	8 outputs	-	Source	Spring	2,046,000
TM3DQ16T	MODULE TM3-16 OUTPUTS TR.SOURCE	16 outputs	-	Source	Screw	2,937,000
TM3DQ16TG	MODULE TM3-16 OUTPUTS TR.SOURCE SPRING	16 outputs	-	Source	Spring	2,937,000
TM3DQ16TK(*)	MODULE TM3-16 OUTPUTS TR.SOURCE HE10	16 outputs	-	Source	HE 10	2,343,000
TM3DQ32TK(*)	MODULE TM3-32 OUTPUTS TR.SOURCE HE10	32 outputs	-	Source	HE 10	4,103,000
TM3DM8R	MODULE TM3-8 IO RELAYS	4 inputs/4 outputs		Sink-source/Relay	Screw	1,870,000
TM3DM8RG	MODULE TM3-8 IO RELAYS SPRING	4 inputs/4 outputs		Sink-source/Relay	Spring	1,870,000
TM3DM24R	MODULE TM3-24 IO RELAYS	16 inputs/8 outputs		Sink-source/Relay	Screw	3,740,000
TM3DM24RG	MODULE TM3-24 IO RELAYS SPRING	16 inputs/8 outputs		Sink-source/Relay	Spring	3,718,000
TM3DQ8U	MODULE TM3-8 OUTPUTS TR.SINK	8 outputs	-	Sink	Screw	1,870,000
TM3DQ8UG	MODULE TM3-8 OUTPUTS TR.SINK SPRING	8 outputs	-	Sink	Spring	1,870,000
TM3DQ16U	MODULE TM3-16 OUTPUTS TR.SINK	16 outputs	-	Sink	Screw	2,662,000
TM3DQ16UG	MODULE TM3-16 OUTPUTS TR.SINK SPRING	16 outputs	-	Sink	Spring	2,662,000
TM3DQ16UK(*)	MODULE TM3-16 OUTPUTS TR.SINK HE10	16 outputs	-	Sink	HE 10	2,134,000
TM3DQ32UK(*)	MODULE TM3-32 OUTPUTS TR.SINK HE10	32 outputs	-	Sink	HE 10	3,718,000

(*) Cable connection: HE 10



TM3DI8G



TM3DI8

Programmable Logic Controller - Modicon M2xx

The Modicon M2xx logic controller offer best in class performance. Available also in book format, the modicon M2xx requires minimal installation and offers tremendous versatility.

PLC Modicon M2xx được thiết kế với hiệu năng cao, đáp ứng hầu hết các nhu cầu dạng trong lĩnh vực chế tạo máy. Bên cạnh đó, với dòng Book được thiết kế theo kiểu mô-dun nhỏ gọn, Modicon M2xx còn có khả năng tối ưu không gian lắp đặt.

Unit price (incl.VAT) in VND

I/O Analog Module 24Vdc

Modicon M2xx

Reference	Description	Type of channels	Analog I/O	I/O range	Resolution	Cable connection	Unit Price
TM3AI2H	MODULE TM3-2ANALOG INPUTS HIGH RES.	Voltage/ current	2 inputs	-10..+10Vdc, 0..+10V/ 0.20 mA, 4.20 mA	16 bits or 15 bits + sign	Screw	4,510,000
TM3AI2HG	MODULE TM3-2ANALOG INPUTS HIGH RES. SPRING	Voltage/ current	2 inputs	-10..+10Vdc, 0..+10V/ 0.20 mA, 4.20 mA	16 bits or 15 bits + sign	Spring	4,510,000
TM3AI4	MODULE TM3-4ANALOG INPUTS	Voltage/ current	4 inputs	-10..+10Vdc, 0..+10V/ 0.20 mA, 4.20 mA	12 bits or 11 bits + sign	Screw	4,444,000
TM3AI4G	MODULE TM3-4ANALOG INPUTS SPRING	Voltage/ current	4 inputs	-10..+10Vdc, 0..+10V/ 0.20 mA, 4.20 mA	12 bits or 11 bits + sign	Spring	4,444,000
TM3AI8	MODULE TM3-8ANALOG INPUTS	Voltage/ current	8 inputs	-10..+10Vdc, 0..+10V/ 0.20 mA, 4.20 mA	12 bits or 11 bits + sign	Screw	5,456,000
TM3AI8G	MODULE TM3-8ANALOG INPUTS SPRING	Voltage/ current	8 inputs	-10..+10Vdc, 0..+10V/ 0.20 mA, 4.20 mA	12 bits or 11 bits + sign	Spring	5,456,000
TM3TI4	MODULE TM3-4 INPUTS TEMPERATURE	Voltage/ current or temperature	4 inputs	Thermocouples, Temperature probes, -10..+10Vdc, 0..+10V/ 0.20 mA, 4.20 mA	16 bits or 15 bits + sign	Screw	5,456,000
TM3TI4G	MODULE TM3-4 INPUTS TEMPERATURE SPRING	Voltage/ current or temperature	4 inputs	Thermocouples, Temperature probes, -10..+10Vdc, 0..+10V/ 0.20 mA, 4.20 mA	16 bits or 15 bits + sign	Spring	5,456,000
TM3TI8T	MODULE TM3-8 INPUTS TEMPERATURE	Temperature	8 inputs	Thermocouples, PTC, NTC	16 bits or 15 bits + sign	Screw	5,786,000
TM3TI8TG	MODULE TM3-8 INPUTS TEMPERATURE SPRING	Temperature	8 inputs	Thermocouples, PTC, NTC	16 bits or 15 bits + sign	Spring	5,786,000
TM3AQ2	MODULE TM3-2ANALOG OUTPUTS	Voltage/ current	2 outputs	-10..+10Vdc, 0..+10V/ 0.20 mA, 4.20 mA	12 bits or 11 bits + sign	Screw	5,049,000
TM3AQ2G	MODULE TM3-2ANALOG OUTPUTS SPRING	Voltage/ current	2 outputs	-10..+10Vdc, 0..+10V/ 0.20 mA, 4.20 mA	12 bits or 11 bits + sign	Spring	5,038,000
TM3AQ4	MODULE TM3-4ANALOG OUTPUTS	Voltage/ current	4 outputs	-10..+10Vdc, 0..+10V/ 0.20 mA, 4.20 mA	12 bits or 11 bits + sign	Screw	5,346,000
TM3AQ4G	MODULE TM3-4ANALOG OUTPUTS SPRING	Voltage/ current	4 outputs	-10..+10Vdc, 0..+10V/ 0.20 mA, 4.20 mA	12 bits or 11 bits + sign	Spring	5,346,000
TM3AM6	MODULE TM3-4ANALOG IN, 2ANALOG OUT.	Voltage/ current	4 inputs/ 2 outputs	-10..+10Vdc, 0..+10V/ 0.20 mA, 4.20 mA	12 bits or 11 bits + sign	Screw	6,138,000
TM3AM6G	MODULE TM3-4ANALOG IN, 2ANALOG OUT, SPRING	Voltage/ current	4 inputs/ 2 outputs	-10..+10Vdc, 0..+10V/ 0.20 mA, 4.20 mA	12 bits or 11 bits + sign	Spring	6,138,000
TM3TM3	MODULE TM3-2 TEMP INPUTS 1ANALOG OUT.	Voltage/ current or temperature	2 inputs/ 1 output	Thermocouples, Temperature probes, -10..+10Vdc, 0..+10V/ 0.20 mA, 4.20 mA	16 bits or 15 bits + sign (for Inputs)/ 12 bits or 11 bits + sign (for outputs)	Screw	5,786,000
TM3TM3G	MODULE TM3-2 TEMP INPUTS 1ANALOG OUT, SPRING	Voltage/ current or temperature	2 inputs/ 1 output	Thermocouples, Temperature probes, -10..+10Vdc, 0..+10V/ 0.20 mA, 4.20 mA	16 bits or 15 bits + sign (for Inputs)/ 12 bits or 11 bits + sign (for outputs)	Spring	5,786,000



TM3AI2H



TM3AI4

Programmable Logic Controller - Modicon M2xx

The Modicon M2xx logic controller offer best in class performance. Available also in book format, the modicon M2xx requires minimal installation and offers tremendous versatility.

PLC Modicon M2xx được thiết kế với hiệu năng cao, đáp ứng hầu hết các nhu cầu dạng trong lĩnh vực chế tạo máy. Bên cạnh đó, với dòng Book được thiết kế theo kiểu mô-dun nhỏ gọn, Modicon M2xx còn có khả năng tối ưu không gian lắp đặt.

Unit price (incl.VAT) in VND



TMH2GDB



TMC2AI2



TMC2AQ2V



TMC2AQ2C

Accessories					
Reference	Description	M221	M241	M251	Unit Price
TMH2GDB	Remote graphic display	x	x	x	5,313,000
TMAM2	Mounting kit for M221 And TM3	x			1,276,000
TMAT2CSET	CONNECTOR SET for M221C - IO	x			682,000
TMAT2MSET	CONNECTOR SET for M221M and TM3 - IO	x			1,056,000
TMAT2MSETG	CONNECTOR SET for M221M and TM3 - IO Spring	x			550,000
TMC2AI2	CARTRIDGE M221-2ANALOG CURRENT INPUTS	x			1,738,000
TMC2TI2	CARTRIDGE M221-2 TEMPERATURE INPUTS	x			2,178,000
TMC2AQ2V	CARTRIDGE M221-2ANALOG VOLTAGE OUTPUTS	x			2,178,000
TMC2AQ2C	CARTRIDGE M221-2ANALOG CURRENT OUTPUTS	x			2,178,000
TMC2SL1	CARTRIDGE M221-1 SERIAL LINE	x			2,178,000
TMC2HOIS01	CARTRIDGE M221-HOISTING 1ANALOG INPUT	x			2,387,000
TMC2PACK01	CARTRIDGE M221-PACKAGING 2ANALOG INPUTS	x			2,629,000
TMC2CONV01	CARTRIDGE M221-CONVEYING 1 SERIAL LINE	x			2,310,000
TMAT4CSET	CONNECTOR SET for M241 - IO		x		1,661,000
TMC4AI2	CARTRIDGE M241-2ANALOG INPUTS		x		4,037,000
TMC4AQ2	CARTRIDGE M241-2ANALOG OUTPUTS		x		4,642,000
TMC4HOIS01	CARTRIDGE M241-HOISTING 1ANALOG INPUT		x		4,840,000
TMC4PACK01	CARTRIDGE M241-PACKAGING 2ANALOG INPUTS		x		4,840,000
TMC4TI2	CARTRIDGE M241-2 TEMPERATURE INPUTS		x		4,642,000
TM4ES4	MODULE NETWORK TM4-4 Ethernet switches		x	x	6,930,000
TM4PDPS1	MODULE NETWORK TM4-1 Profibus DP slave		x	x	7,986,000
TMACBL1	CABLE for M2xx integrated analog input	x	x	x	1,628,000
TMASD1	MEMORY CARD 256MB for M2xx controller	x	x	x	990,000
TMAT2PSET	CONNECTOR SET for M2X1 - power supply and RS485	x	x	x	1,386,000

Magelis GTU

The high performance modular HMI panel

Build the HMI panel you have always wanted

The innovative design of Magelis™ GTU from Schneider Electric gives you a unique opportunity to create a state-of-the-art HMI configuration tailored to the specific requirements of your application. Define your preferred combination of panel box and different displays to build your perfect HMI, while keeping the number of references in your inventory to the minimum.

- Premium Box: with Real time OS
- Open Box: with Window OS

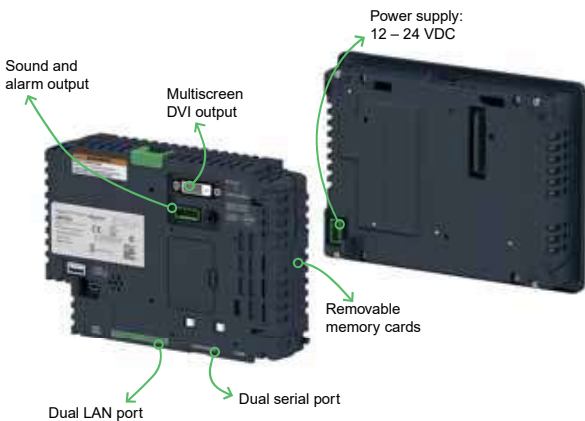

So many applications One flexible HMI

- Enhanced performance and security of data flow with dual LAN to separate IT and PLC communication.
- Open connectivity with 2 serial ports with different signal types, 3 to 6 USB ports, optional interface for fieldbus, support of all main industrial protocols.
- Easy maintenance through dual removable storage units, one for system and one for user data.
- Improved visibility of alarms with speakers and alarm/buzzer output.
- Reliable communication in complex grounding applications, with isolation on the RJ45-RS485 port.

Boost your efficiency With an open HMI

Magelis GTU was designed to offer the flexibility of Microsoft Windows 7 embedded, allowing you to add new functionalities to your HMI application while maintaining the security of your operations.

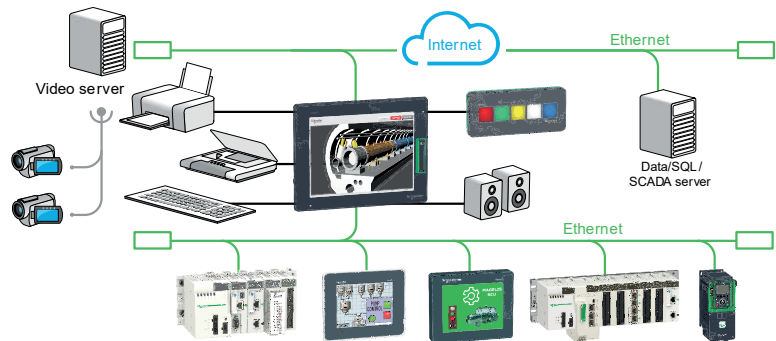

Magelis GTU Open Add-on tools preinstalled:



Magelis STO

The full-color, compact HMI

A high-quality display in a compact size

Magelis STO, the newest member of the Magelis HMI range, offers:

- **Efficient and intuitive operation**

Magelis STO supports smartphone-style navigation, which simplifies application design. Furthermore, Schneider Electric's Vijeo™ XD 2016 configuration software simplifies design and provides data management tools to optimize screen usage. Together, these features make application engineering and usage both efficient and intuitive.

- **Larger display, higher resolution**

Magelis STO's 64k TFT color display offers eight times more pixels and a 50 percent larger screen compared with its predecessors, but the device is only 20 percent larger. This enables original equipment manufacturers to keep machine size at a minimum while maximizing screen area. With high-resolution screen quality, the picture is uniquely crisp for a device of this class.



Magelis STO with optional adapter frame

Vijeo Designer XD

The next-generation configuration software for Magelis

Gesture experience

- > Multi-touch zoom in/zoom out, slide, pinch and stretch options similar to smart phones for enhanced user experience
- > Intuitive and attractive with finely designed ergonomic features

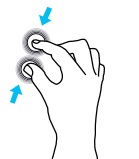

Pinch to zoom



Stretch to zoom



Slide to scroll

Detailed vector graphics

- > Zoom in/zoom out feature for detailed access in vector mode
- > Animation features with rotating objects and dynamic drawings



Design theme



Unit price (incl.VAT) in VND

Universal display modules

Data entry method	Size	Resolution	Colors	Touch type	Option	Reference	Unit Price
Advanced display							
Via touch screen, format 16/9	7"	800 × 480	262 K	Single resistive	No	HMIDT351	(*)
	10"	1280 × 800	262 K	Single resistive	No	HMIDT551	(*)
	12"	1280 × 800	262 K	Single resistive	No	HMIDT651	(*)
Smart display							
Via touch screen, format 4/3	10.4"	800 × 600	16M	Multi resistive	Front USB Brightness sensor, Scaler	HMIDT542	(*)
	12.1"	1024 × 768	16M	Multi resistive	Front USB Brightness sensor, Scale	HMIDT642	(*)
	15"	1024 × 768	16M	Multi resistive	Front USB Brightness sensor, Scaler	HMIDT732	(*)



HMIDT351



HMIDT642



HMIG3U



HMIG5U

Magelis GTU Universal box modules

Operating system	RAM	Storage	USB ports	Communication	Multimedia	Reference	Unit Price
Premium box							
Real Time	256MB	2SD cards	2 Hosts (type A), 1 Device (mini-B)	2 Serial 2 Ethernet Gigabit	Sound output	HMIG3U	(*)
Open box							
Windows® 7 Embedded	2 GB	2 CFast cards 1 SD card	3 Hosts (type A), 1 Device (mini-B)	2 Serial 2 Ethernet Gigabit	Sound output, Microphone, External display output (DVI)	HMIG5U	(*)

(*) Please contact Schneider Electric distributor for price request

Unit price (incl.VAT) in VND

Magelis GTO - Touch Screen

Description	Reference	Unit Price
3.5" QVGA TFT LCD screen, 320 x 240 pixels - 2 x serial link	HMIGTO1300	19,694,400
3.5" QVGA TFT LCD screen, 320 x 240 pixels - 1 x serial link - 1 x Ethernet	HMIGTO1310	20,843,900
5.7" QVGA TFT LCD screen, 320 x 240 pixels - 2 x serial link	HMIGTO2300	24,398,000
5.7" QVGA TFT LCD screen, 320 x 240 pixels - 2 x serial link - 1 x Ethernet	HMIGTO2310	26,330,700
5.7" QVGA screen, 320 x 240 pixels, with Stainless Steel frame (IP 66K) - 2 x serial link - 1 x Ethernet	HMIGTO2315	32,026,500
7.0" WVGA (Wide) TFT LCD screen, 800 x 480 pixels - 2 x serial link - 1 x Ethernet	HMIGTO3510	32,689,800
7.5" VGA TFT LCD screen, 640 x 480 pixels - 2 x serial link - 1 x Ethernet	HMIGTO4310	37,847,700
10.4" VGA TFT LCD screen, 640 x 480 pixels - 2 x serial link - 1 x Ethernet	HMIGTO5310	41,174,100
10.4" VGA screen, 640 x 480 pixels, with Stainless Steel frame (IP 66K) - 2 x serial link - 1 x Ethernet	HMIGTO5315	58,373,700
12.1" SVGA TFT LCD screen, 800 x 600 pixels - 2 x serial link - 1 x Ethernet	HMIGTO6310	45,310,100
12.1" SVGA screen, 800 x 600 pixels, with Stainless Steel frame (IP 66K) - 2 x serial link - 1 x Ethernet	HMIGTO6315	61,221,600



HMIGTO6310



HMIGTO5315

Unit price (incl.VAT) in VND



HMISTO512



HMISTO735



HMISTU655



XBTN

Magelis STO		
Description	Reference	Unit Price
3.4" monochrome touch screen		
Magelis STO 3"4 Touch Screen, 3-colors backlight Green/Orange/Red, resolution 200x80 pixels, 24V DC supply, 1 x serial line RS232/RS485-RJ45 port, 2x USB ports type mini-B device & type A host	HMISTO511	(*)
Magelis 3"4 Touch Screen, 3-colors backlight White/Pink/Red, resolution 200x80 pixels, 24V DC supply, 1 x serial line RS232/RS485-RJ45 port, 2x USB ports type mini-B device & type A host	HMISTO512	(*)
4.3" color touch screen		
Magelis 4.3 inch TFT, 64K color 480x272 pixels, analog touch panel, serial RS232C I/F (terminal block), USB I/F type A & mini B x 1 each, DC power supply (12V/24V)	HMISTO705	10,679,900
Magelis 4.3 inch TFT 64K color, 480x272 pixels, analog touch panel, serial RS232C/485 I/F (RJ-45), USB I/F type A & mini B x 1 each, DC power supply (12V/24V)	HMISTO715	11,179,300
Magelis 4.3 inch TFT 64K color, 480x272 pixels, analog touch panel, Ethernet I/F (RJ-45), USB I/F type A & mini B x 1 each, DC power supply (12V/24V)	HMISTO735	
Magelis STU		
Magelis STU with display 3"5 Touch Screen, 65K colors, resolution QVGA 320x240 pixels, 24V DC supply, one serial line RS232/RS485-RJ45 port, one Ethernet 10/100BaseT RJ45 port, two USB ports type mini-B device & type A host	HMISTU655	15,088,700
Magelis STU with display 5"7 Touch Screen, 65K colors, resolution QVGA 320x240 pixels, 24V DC supply, one serial line RS232/RS485-RJ45 port, one Ethernet 10/100BaseT RJ45 port, two USB ports type mini-B device & type A host	HMISTU855	20,234,500
Magelis XBT N - Compact display units		
Description	Reference	Unit Price
Compact Display 2x20 characters, powered by PLC	XBTN200	5,800,300
Compact Display 4x20 characters, powered by PLC	XBTN400	10,524,800
Compact Display 4x20 characters, powered by 24Vdc	XBTN401	12,804,000
Cable, Programming cable for XBT-N200/-N400 optimum, RJ45MinDin	XBTZ945	1,100,000
Cable to connect XBT N/R with Twido, Premium PLCs, 2.5m	XBTZ9780	891,000

HMI Design Software



Vijeo Designer		
Description	Reference	Unit Price
Vijeo Designer, Single license	VJDSNDTGSV62M	20,589,800
Vijeo Designer, Single license, XBTGT USB cable	VJDSUDTGAV62M	26,205,300
Vijeo Designer, Single license, Group license	VJDGNDTGSV62M	31,820,800
Vijeo Designer, Single license, Team license	VJDTNDTGSV62M	87,973,600
Vijeo Designer XD (for STO7, GTU)		
Description	Reference	Unit Price
Vijeo XD Pro paper License (support GTU/GTO/STO7/iPC)	HMIPELCZLSPMZZ	21,727,200
Vijeo XD Pro digital License (support GTU/GTO/STO7/iPC)	HMIPELCZLSPAZZ	21,061,700
Vijeo XD Exp paper License (support STO7 only)	HMIPELCZLSPMZZ	5,542,900
Vijeo XD RunTime paper License for Magelis iPC	HMIRTMZLSPMZZ	26,605,700

Accessories

Download cable		
Download cable for mini-USB port	BMXXCAUSBH018	1,213,300
Battery for RTC		
For HMISTO back-up of real time clock data during power-off	HMIZSRTC1	1,196,800
Cable to connect to PLC		
Please see catalogue for the information		

Selection Guide



High-performance HMI



Standard HMI and Touch PLC



Industrial PC

When you choose Pro-face, you choose a world-class interface.

Pro-face continues to provide you and your customers worldwide with Connectivity, Innovation, Service & Support to meet customers' challenges in starting their IoT systems.

Easily start your IoT system

Connectivity

Our products connect with more than 800 types of devices including PLCs. An HMI-centered system will allow a network to link new and existing facilities, and link to office and factory networks. In addition, open connectivity enables collaboration between HMI and equipment, offering a wide range of solutions.



Advanced product development

Innovative

The GP Series, the world's first programmable display (HMI), has been a top-selling Pro-face brand since it was first developed in 1989, and today we continue to produce advanced hardware and software with state-of-the-art technology.

Hardware

Unique specifications and features, meeting the exact needs of customers



Software

Combining multiple software tools to deliver added value





Service & support delivering certainty around the world

Service & Support

We help customers all around the world by providing customized, flexible services and support.



Find the best HMI from our range of products.

Data volume	 [Simple Machine]	 [Complex Machine]	 [Data Management]
+ + + +			<div data-bbox="992 621 1338 1014"> <p>General OS</p> <p>Industrial PC</p> <p>PS5000 Series</p> <p>page 9</p> <p>Industrial computer with environmental resistance and maintainability that realizes introduction of IT and networking into the manufacturing sites.</p> <p>BLUE Open Studio</p> <p>page 17</p> </div>
+ + +		<div data-bbox="716 947 1029 1436"> <p>Real-time OS</p> <p>High-Performance HMI</p> <p>SP5000 Series</p> <p>page 3</p> <p>The flagship model achieving high performance and robust network security.</p> <p>BLUE GP-Pro EX</p> <p>page 13 page 15</p> </div>	
+ +	<div data-bbox="464 1157 777 1570"> <p>Real-time OS</p> <p>Standard HMI/ HMI with Controller</p> <p>GP4000 Series</p> <p>page 5</p> <p>Standard HMI with a wide range of models to meet specific customer needs.</p> </div>		
+	<div data-bbox="464 1587 777 1885"> <p>LT4000M Series</p> <p>page 8</p> <p>Integrated HMI with control functions that offer cost savings for the equipment and space savings in the panel.</p> <p>BLUE GP-Pro EX</p> <p>page 13 page 15</p> </div>		<div data-bbox="743 1635 1248 1885"> <p>Mobile OS</p> <p>Remote monitoring</p> <p>Pro-face Remote HMI</p> <p>page 19</p> <p>Suitable for checking the device information anywhere with a tablet or smartphone, as if carrying around the display.</p> </div>

High-Performance HMI

SP5000 series



Flagship model achieving high performance and robust network security

The SP5000 series is an HMI that provides information quickly and efficiently, and promotes "smartification" of your factories.

Flagship

01 Manage more information in various forms

Fully compatible for direct use with Windows applications, the SP5000 can handle materials, such as manuals and error codes, without conversion.



No need to bring PC for debugging and JOB reprogramming



02 Simple activation by inserting cards

Display data is scalable to fit multiple sizes of monitors, which can be applied to new equipment for mass production. There is no need for on-site data transfer, because SP5000 models are activated when the SD card is inserted.

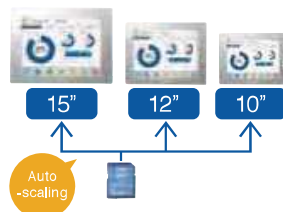

This is a time-efficient way to carry out on-site troubleshooting.



03 Network segmentation

All displays of SP5000 series have two Ethernet I/F ports as standard. The IP address is changed on the SP5000 at delivery

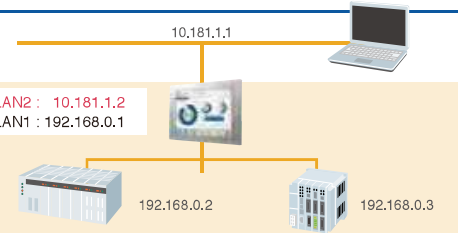

And more...

Cost Reduction and Equipment Improvement with I/O expansion.



Using the option unit allows you to connect equipment that requires simple control + HMI, additional I/O expansion and remote I/O expansion.

Standard HMI

GP4000 series



Standard

Varied and flexible lineup satisfying customers needs

Combines abundant functions with a broad line-up of versatile models to meet the specific needs of every customer.

01 Widest line-up in the Pro-face brand

From classic to unique, we offer a wide range of choices to meet any application.



02 Compatible with our legacy models



Data in GP-PRO/PBIII for Windows or later is convertible using project converter. Smooth transition to the latest models.



USB expansion options unique to Pro-face

Reduce excess inventory of indicator lights

EZ Tower Light Model: PFXZCETWHA1 (tube mounting with fixing plate)
Model: PFXZCETWW1 (base mounting)

With this single model, multiple colors and sounds can be set. Capable of indicating the state of equipment.



LED lamps adaptable to various types of setting

Configuration from HMI
4 colors (red, green, blue, and yellow)
and 3 modes (off, on, and blink)
Number of lamps: 3
Buzzer patterns: 4

Combining switch and lamp

EZ Illumination Switch Model: PFXZCCEUSG1

Improve visibility with 6-color illumination. Reduce man-hours for control panel installation and wiring



LED light switches accept a wide range of settings

Configuration by HMI design software
6 colors (red, green, blue, yellow, white, and orange)
and 3 modes (off, on, and blink)
Protection structure: IP65 (front face where panel is embedded)
Mount: 22φ circular mounting hole

Work-saving for inputting repeated values

EZ Numpad Model: PFXZCCEUKB1

Reduces screens needed for value input

- Alphanumeric and customizable function keys (Set by HMI design software)
- Protection: IP65
- Mount: 22φ circular mounting hole



Even more improved security

EZ Fingerprint Recognition Unit Model: PFXZCCEUSS1

Prevents spoofing by changing from ID / PW to fingerprint authentication! Combination with operation logs enables accurate tracking of access.

- Register up to 100 people
- Protection: IP65
- Mount: 22φ circular mounting hole
- Error rate: 0.1% or less



Adding second LAN port with independent IP address

EZ LAN Adapter Model: PFXZCGEUE1

The GP4000 series also allows you to securely set up a network.

- Same functions as built-in LAN port
- 10BASE-T / 100BASE-TX
- Limited to GP4000 standard models



Also can be used with Pro-face products other than GP4000 series.

Touch PLC

LT4000M series

Hybrid display
with control function

Since the release of the world's first controller with display (CGP model) in 1996, our products have gained a reputation for enabling customers to save space as well as equipment costs.

5.7" 3.5"

Flexible

01 Simple design without PLC

Connectivity with a range of devices

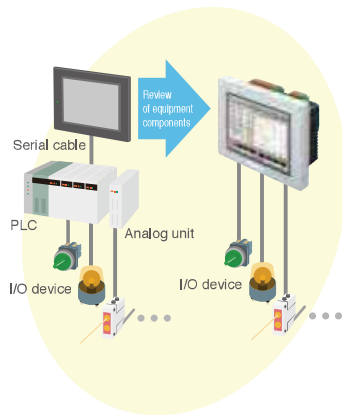

02 Easy to create control panels

Easily retrofittable, requiring only 22φ circular mounting holes

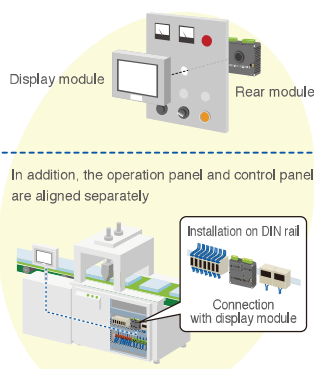

Product Name	Length	Model
Display module	3m	PFZXMMADSM31
Rear module separation cable	5m	PFZXMMADSM51

03 Create systems with reduced wiring using remote I/O.

Compatible with European standard CANopen. Communicate with CANopen compatible slave units with LT as master

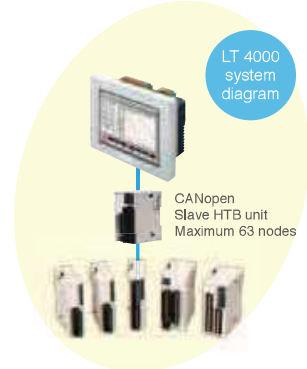

DIO/AIO extended EX module
Up to 7 units per HTB unit

Model	LT-4301TM		LT-4201TM	
	PFXLM4301TADD*	PFXLM4301TADA*	PFXLM4201TADD*	PFXLM4201TADA*
Display Size	5.7"		3.5"	
Rated Input Voltage	24Vdc			
Control	DIO	AIO+DIO	DIO	AIO+DIO
Resolution	320 x 240pixels (QVGA)			
Touch Panel Type	Resistive Film (analog)			
Application Memory	16MB			
Backup Memory	NVSARAM 128KB			
Logic program area	FLASH EPROM 132KB			
Variable area	NVSARAM 64KB			
Interface	RS-232C/485 x 1 Ethernet x 1 USB(Type A) x 1 USB(mini B) x 1 CANopen (Master) x 1			
Structure	IP65F			
External Dimensions	Display Module:W163 x H129.4 x D17.5mm(W6,42 x H5,09 x D0,69 in.) Rear Module:W128 x H108 x D60,15mm(W5,03 x H4,25 x D2,36 in.)		Display Module:W97.6 x H80 x D16,2mm(W3,8 x H3,1 x D0,63 in.) Rear Module:W128 x H108 x D60,15mm(W5,03 x H4,25 x D2,36 in.)	
Panel Cut Dimensions	φ22.5mm			
Connectable Devices	4			
Built-in DIO (Input)	20 points (configurable 2 x High Speed counter/Pulse catch or 1 Up/Down High Speed Counter)	12 points (configurable 2 x High Speed counter/Pulse catch or 1 Up/Down High Speed Counter)	20 points (configurable 2 x High Speed counter/Pulse catch or 1 Up/Down High Speed Counter)	12 points (configurable 2 x High Speed counter/Pulse catch or 1 Up/Down High Speed Counter)
Built-in DIO (Output)	12 points (configurable 2 x PWM/Pulse)	8 points (configurable 2 x PWM/Pulse)	12 points (configurable 2 x PWM/Pulse)	8 points (configurable 2 x PWM/Pulse)
Built-in AIO (Input)	0 points	4 points (Voltage/Current x2 - Temperature input x2 included)	0 points	4 points (Voltage/Current x2 - Temperature input x2 included)
Built-in AIO (Output)	0 points	2 points (Voltage/Current x2)	0 points	2 points (Voltage/Current x2)

Industrial PC

PS5000 series



IPC with highest level of performance in the industry.

20 years after releasing the world's first industrial computer, a new model is available with the highest level of performance and reliability in the industry. Two types are available for different applications. Combined with Pro-face software, we can provide solutions beyond the boundaries of the standard IPC.

Powerful Solution

01 High Performance

The PS5000 series achieves a 280% performance increase compared to conventional models. It also demonstrates its power when used with high-spec equipment that require high-speed processing.

For machines requiring high performance and high accuracy...

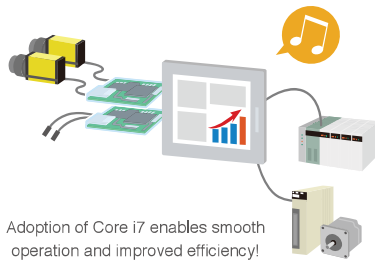

Adoption of Core i7 enables smooth operation and improved efficiency!



PS5000 is a Microsoft Azure certified device. Please contact us regarding supported models.

02 Integration with software for IoT

A wide range of software applications is available to easily gather and utilize any data to be visualized among various sources (big data).

Pro-face Remote HMI
Monitor the situation of the entire facility from remote locations.



Pro-Server EX



Automatically collect field data from MS Excel without programming!

Pro-face Remote HMI Server



PS5000 series

BLUE Open Studio

Display and analyze on-site data collected at high speed



03 Reliable operation

Remote System Status Monitoring and Control



CPU load percentage, temperature, memory, S.M.A.R.T., etc.

Power shutdown is also possible with a smartphone

Fanless models for all devices



There is no need to change the fan on a regular basis, thus reducing maintenance costs and management effort.

HDD mirroring



Convenient hot-swapping for HDD replacement (when using soft mirroring)

VESA installation

Options to install VESA arms are available. No need to produce or buy separate housing.

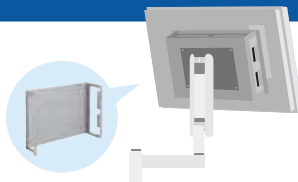

Flexible installation without panel

Several options are available to fit the required interface. Choose from options such as Gigabit Ethernet, DIO and serial for even more functions.



Multi-Converter



Step Towards IoT

A multi-converter that offers a solution for data collection, connecting to a wide variety of equipment as well as PLC

Smart Gateway

01 Merge data from different devices

Unify protocols and collect data efficiently

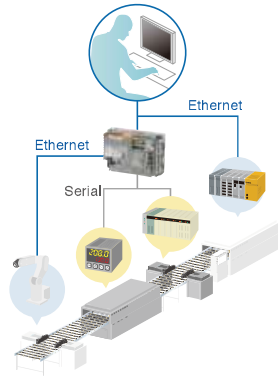

02 Tablet-based on-demand HMI

See status of equipment or devices in the right place at the right time.



03 HMI for ANDON (Large-size monitor)

Optimize work by sharing production status.

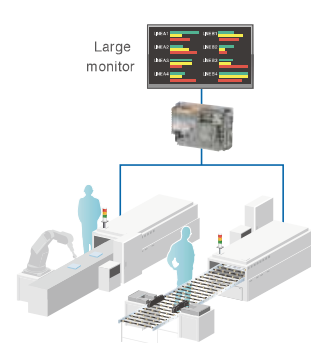

04 Easily collect PLC data by network or USB memory

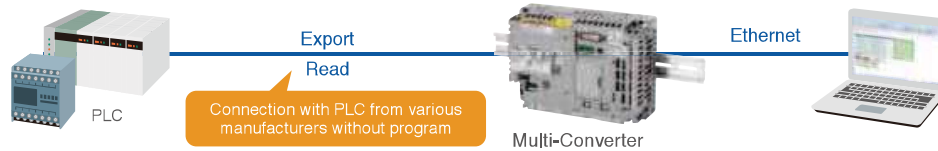

	SP5000 (Open BOX) Model	SP5000 (Power BOX) Model	LT4000M Model	GP4000M Model
Base module	PFXSP5B41	PFXSP5B10	PFXLM4B01DAC PFXLM4B01DAK PFXLM4B01DDC PFXLM4B01DDK	PFXGM4B01D
Adapter	PFXZCDAEXP1		PFXZXMADSA1	

FANUC limited model (Model: PFXLM4B01DAKFF) is available. Data collection from CNC of old machines.

Data collection device

Pro-face IoT Gateway

Even if the serial communication I/F is occupied, data can be collected by relaying between devices. Connectable without changing the program of the HMI and PLC. Data can be collected while maintaining communication of old devices.

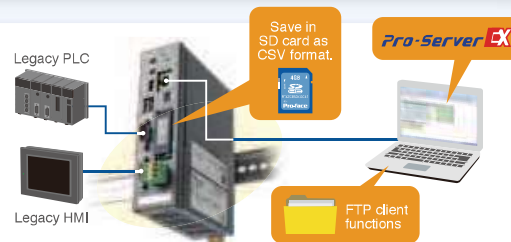

For checking in multiple places

For separating from BOX PC (5 m, 100 m)

Screens can be expanded with FA specifications for displays, industrial computers and personal computers.

As embedded displays with industrial specification, 3 types of DVI-D/Display Port/Ethernet connection are available.

In addition, acquisition of overseas standards and installation of VESA are applicable.

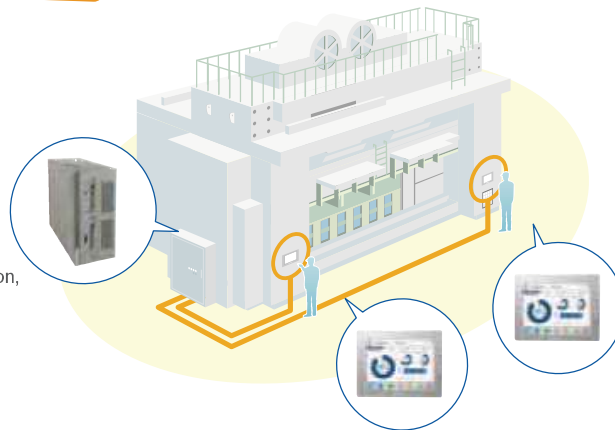

Flat Panel Monitors FP5000 series

Industrial flat panel display with high environmental resistance that allows multi-gesture even when wearing gloves.

- Replaceable from FP3000 series
- Automatic scaling functions
- Windows XP compatibility

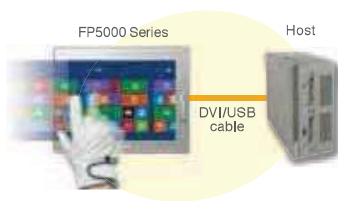

	FP-5700TPD	FP-5600TPD
Model	PFXFP5700TPD	PFXFP5600TPD
Display Size	15"	12"

Hi-Performance HMI SP5000 Multi Display Adapter

Expansion unit for using the SP5000 series display as an Ethernet flat panel display.

- Connectable up to 100 meters with one Ethernet cable
- Support both duplicate and extended mode, a touch operation exclusive control

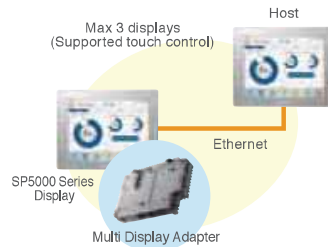

	Multi Display Adapter
Model	PFXZCDADEXR1

Industrial PC PS5000 Display Adapter

Extension unit for the SP5000 displays allowing you to add a high-quality, glass front display to a SP5000 host.

- Lineup with up to 22" wide type
- Compatible to full HD TFT (1,920 x 1,080 pixels)

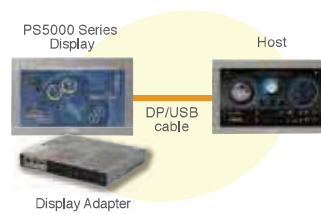

	Display Adapter
Model	PFXZPPDADDP2

	FP5000 Series		SP5000 Series Display + Multi Display Adapter		PS5000 Series Display + Display Adapter	
	Resistive Film (Analog)		Capacitive (5 simultaneous touch)	Resistive Film (Analog)	Capacitive (5 simultaneous touch)	Resistive Film (Analog)
Touch Panel Type	Resistive Film (Analog)		Capacitive (5 simultaneous touch)	Resistive Film (Analog)	Capacitive (5 simultaneous touch)	Resistive Film (Analog)
Size	15" / 12"		19" wide / 15" wide	15" / 12" wide / 12" / 10" wide / 10" / 7" wide	22" wide / 19" wide / 15" wide / 12" wide	15" / 12"
Host	PS5000 / PS4600 / PE4000B / SP5000 Open Box (SP-5B41) / General-purpose PC		SP5000 Open Box (SP-5B41) / PS5000 / PS4600 / PE4000B / General-purpose PC		PS5000 / General-purpose PC	
OS	WinXP (32 bit), WES2009 Win7 (32/64 bit), WES7 Win8 (32/64 bit) Win8.1 Industry (64 bit)		Win7 (32/64 bit), WES7 (64 bit) Win8 (32/64 bit) Win8.1 Industry (64 bit)		Windows10 IoT Enterprise 2016 LTSB (64bit) Win7 (32/64 bit), WES7 (64 bit) Win8.1 Industry (64 bit)	
Video	DVI-D		Ethernet		Display Port	
Touch Panel Type	USB (Type B)				USB (Type B)	
Distance to connect	5m (16ft.)		100m (328ft.)		5m (16ft.)	
Rated Input Voltage	12...24Vdc		12...24Vdc		100...240Vac (Option) / 24Vdc	
Surrounding air temperature	0...60°C		0...60°C		0...55°C	



Versatile Software

Revolutionary new software, BLUE offers an alternative experience in hardware design. Anyone can easily create and change dynamic screens that allow for gesture operation. BLUE provides a ground-breaking versatile design style.

Screen editor software



Standard screen editor software

Enables HMI screen and logic programming. Screen customization can be performed with ease due to many functions that promote compatibility with legacy applications and reduce development time.

BLUE Line Management Lite SCADA Open Studio

Flexible Software

Pro-face BLUE Open Studio is a development and runtime software that incorporates all of the tools users need to create SCADA HMI applications, dashboards and OEE interfaces.



Data management software



A simple way to start networking to enhance the communication between the office and the manufacturing site.

Real-time visualization and analysis of data from production sites. Remote machine monitoring and transfer of work instructions to increase efficiency between the production site and the office.

Remote monitoring

Various remote monitoring software to meet the exact needs of every customer.

Accurately convey vital information in a timely and effective manner to make your factory a "smart factory". Remote machine monitoring and transfer of work instructions to increase efficiency between the production site and the office.



Secure Remote Access over Internet

Pro-face Connect

Connect and Go

Pro-face Connect is a ready-to-use embedded HMI service to access machines remotely and securely.

Terminal blocks

NSYTRV screw terminal blocks are components that are well established throughout the world and are suitable for vast majority of connection applications

NSYTRV terminal blocks ensure quality, safety and the operational availability of the equipments

Meet requirement of IEC/EN 60947-7-1

Max Voltage 1000V

Max Rated current: from 32A to 309A

Certifications: UL, CSA, VDE, ATEX, IECEx, GL, LR, DNV, GOST

Screw terminal blocks

Đầu nối NSYTRV phù hợp với hầu hết các ứng dụng đấu nối trên toàn thế giới

Đầu nối NSYTRV đảm bảo chất lượng, an toàn và khả năng hoạt động của các thiết bị

Phù hợp với tiêu chuẩn IEC/EN 60947-7-1

Điện áp hoạt động tối đa: 1000V

Dòng điện tối đa: từ 32A đến 309A

Tiêu chuẩn: UL, CSA, VDE, ATEX, IECEx, GL, LR, DNV, GOST

Unit price (incl.VAT) in VND

Screw terminal block- passthrough. Đầu nối dạng siết ốc



Normal c.s.cmm ²	Type of connection	Reference Grey color	Type of block	Lot size	Unit Price	Reference Green/Yellow	Type of block	Lot size	Unit Price
2.5	1 pole - 1x1	NSYTRV22	Passthrough	50	22,000	NSYTRV22PE	PE	50	93,500
4	1 pole - 1x1	NSYTRV42	Passthrough	50	22,000	NSYTRV42PE	PE	50	74,800
6	1 pole - 1x1	NSYTRV62	Passthrough	50	38,500	NSYTRV62PE	PE	50	99,000
10	1 pole - 1x1	NSYTRV102	Passthrough	50	50,600	NSYTRV102PE	PE	50	118,800
16	1 pole - 1x1	NSYTRV162	Passthrough	50	64,900	NSYTRV162PE	PE	50	169,400
35	1 pole - 1x1	NSYTRV352	Passthrough	50	127,600	NSYTRV352PE	PE	50	253,000
50	1 pole - 1x1	NSYTRV502	Passthrough	10	484,000	NSYTRV502PE	PE	10	1,084,600
70	1 pole - 1x1	NSYTRV702	Passthrough	10	861,300				
95	1 pole - 1x1	NSYTRV952BB	Passthrough lug to lug	10	514,800				
95	1 pole - 1x1	NSYTRV952BC	Passthrough lug to connection	10	831,600				
150	1 pole - 1x1	NSYTRV1502BB	Passthrough lug to lug	10	1,007,600				

Screw terminal block- double deck passthrough. Đầu nối dạng siết ốc



Normal c.s.cmm ²	Type of connection	Reference Grey color	Type of block	Lot size	Unit Price	Reference Green/Yellow	Type of block	Lot size	Unit Price
4	1 pole - 1x2	NSYTRV43	Passthrough multi pole	50	70,400	NSYTRV43PE	PE multi pole	50	174,900
4	1 pole - 2x2	NSYTRV44	Passthrough multi pole	50	75,900	NSYTRV44PE	PE multi pole	50	202,400
2.5	2 pole - 1x1	NSYTRV24D	Passthrough double deck	50	69,300	NSYTRV24DPE	PE double deck	50	260,700
4	2 pole - 1x1	NSYTRV44D	Passthrough double deck	50	75,900	NSYTRV44DPE	PE double deck	50	316,800
2.5	3 pole - 1x1	NSYTRV26T	Passthrough triple deck	50	133,100				

Screw terminal block- Disconnect. Đầu nối dạng siết ốc



Normal c.s.cmm ²	Type of connection	Reference Grey color	Type of block	Lot size	Unit Price				
4	1 pole - 1x1	NSYTRV42SC	Disconnect (blade)	50	95,700				
4	1 pole - 1x1	NSYTRV42TB	Disconnect (for carrier)	50	73,700				
4	2 pole - 1x1	NSYTRV42SCD	Disconnect double deck	50	258,500				
16	1 pole - 1x1	NSYTRV162SF	Disconnect fix carrier	50	287,100				
4	1 pole - 1x1	NSYTRV42SF5	Disconnect lever-type fuse	50	184,800				
16	1 pole - 1x1	NSYTRV42SF6	Disconnect lever-type fuse	50	330,000				

Terminal blocks

NSYTRV screw terminal blocks are components that are well established throughout the world and are suitable for vast majority of connection applications

NSYTRV terminal blocks ensure quality, safety and the operational availability of the equipments

Meet requirement of IEC/EN 60947-7-1

Max Voltage 1000V

Max Rated current: from 32A to 309A

Certifications: UL, CSA, VDE, ATEX, IECEx, GL, LR, DNV, GOST

Screw terminal blocks

Đầu nối NSYTRV phù hợp với hầu hết các ứng dụng đầu nối trên toàn thế giới

Đầu nối NSYTRV đảm bảo chất lượng, an toàn và khả năng hoạt động của các thiết bị

Phù hợp với tiêu chuẩn IEC/EN 60947-7-1

Điện áp hoạt động tối đa: 1000V

Dòng điện tối đa: từ 32A đến 309A

Tiêu chuẩn: UL, CSA, VDE, ATEX, IECEx, GL, LR, DNV, GOST

Unit price (incl.VAT) in VND



Screw terminal block- Measuring. Đầu nối dạng siết ốc

Normal c.s.cmm ²	Type of connection	Reference Grey color	Type of block	Lot size	Unit Price	Reference Green/Yellow	Type of block	Lot size	Unit Price
6	1 pole - 1x1	NSYTRV62TTD	Knife disconnect	50	199,100	NSYTRV62TTPE	PE	50	396,000
6	1 pole - 1x1	NSYTRV62TT	Passthrough	50	283,800				

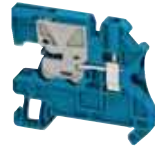

Screw terminal block- Neutral disconnect. Đầu nối dạng siết ốc

Normal c.s.cmm ²	Type of connection	Reference Grey color	Type of block	Lot size	Unit Price				
4 (6)	1 pole - 1x1	NSYTRV42NE	Neutral disconnect	50	115,500				
6 (10)	1 pole - 1x1	NSYTRV62NE	Neutral disconnect	50	127,600				



Screw terminal block- miniature passthrough. Đầu nối dạng siết ốc loại nhỏ

Normal c.s.cmm ²	Type of connection	Reference Grey color	Type of block	Lot size	Unit Price	Reference Green/Yellow	Type of block	Lot size	Unit Price
2.5	1 pole - 1x1	NSYTRV22M	Passthrough	50	46,200	NSYTRV22MPE	PE	50	130,900
4	1 pole - 1x1	NSYTRV42M	Passthrough	50	49,500	NSYTRV42MPE	PE	50	138,600

Spring technology is a type of connection that requires no maintenance and ensures the separation of mechanical and electrical function

NSYTRR spring terminals reduce wiring time and eliminate the need of regular re-tightening.

NSYTRR terminal blocks ensure quality, safety and the operational availability of the equipments

Meet requirement of IEC/EN 60947-7-1

Max Voltage 1000V

Max Rated current: from 31A to 90A

Certifications: UL, CSA, VDE, ATEX, IECEx, GL, LR, DNV, GOST

Đầu nối công nghệ lò xo là loại đầu nối không cần bảo trì và đảm bảo cách ly chức năng cơ và điện

Đầu nối NSYTRR giảm thời gian đấu dây và hạn chế siết dây thường xuyên

Đầu nối NSYTRR đảm bảo chất lượng, an toàn và khả năng hoạt động của các thiết bị

Phù hợp với tiêu chuẩn IEC/EN 60947-7-1

Điện áp hoạt động tối đa: 1000V

Dòng điện tối đa: từ 31A đến 90A

Tiêu chuẩn: UL, CSA, VDE, ATEX, IECEx, GL, LR, DNV, GOST

Unit price (incl.VAT) in VND

Spring terminal block- passthrough. Đầu nối dạng lò xo

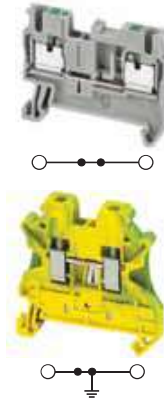

Nominal c.s.cmm ²	Type of connection	Reference Grey color	Type of block	Lot size	Unit Price	Reference Green/Yellow	Type of block	Lot size	Unit Price
2.5	1 pole - 1x1	NSYTRR22	Passthrough	50	25,300	NSYTRR22PE	PE	50	70,400
2.5	1 pole - 1x2	NSYTRR23	Passthrough	50	30,800	NSYTRR23PE	PE	50	145,200
2.5	1 pole - 2x2	NSYTRR24	Passthrough	50	35,200	NSYTRR24PE	PE	50	136,400
4	1 pole - 1x1	NSYTRR42	Passthrough	50	37,400	NSYTRR42PE	PE	50	100,100
4	1 pole - 1x2	NSYTRR43	Passthrough	50	38,500	NSYTRR43PE	PE	50	157,300
4	1 pole - 2x2	NSYTRR44	Passthrough	50	70,400	NSYTRR44PE	PE	50	198,000
6	1 pole - 1x1	NSYTRR62	Passthrough	50	46,200	NSYTRR62PE	PE	50	159,500
6	1 pole - 1x2	NSYTRR63	Passthrough	50	75,900				
10	1 pole - 1x1	NSYTRR102	Passthrough	50	70,400	NSYTRR102PE	PE	50	201,300
16	1 pole - 1x1	NSYTRR162	Passthrough	50	129,800	NSYTRR162PE	PE	50	271,700

Spring terminal block- double deck passthrough. Đầu nối dạng lò xo



Nominal c.s.cmm ²	Type of connection	Reference Grey color	Type of block	Lot size	Unit Price	Reference Green/Yellow	Type of block	Lot size	Unit Price
2.5	2 pole - 1x1 1 pole - 2x2 (PE)	NSYTRR24D	Passthrough double deck	50	84,700	NSYTRR24DPE	PE double deck	50	268,400
4	2 pole - 1x1 1 pole - 2x2 (PE)	NSYTRR44D	Passthrough double deck	50	99,000	NSYTRR44DPE	PE double deck	50	324,500
2.5	3 pole - 1x1	NSYTRR26T	Passthrough 3 levels	50	140,800				

Spring terminal block- Disconnect. Đầu nối dạng lò xo



Nominal c.s.cmm ²	Type of connection	Reference Grey color	Type of block	Lot size	Unit Price				
2.5	1 pole - 1x1	NSYTRR22SC	Disconnect (blade)	50	113,300				
2.5	1 pole - 1x2	NSYTRR23SC	Disconnect (blade)	50	128,700				
2.5	1 pole - 1x1	NSYTRR22TB	Disconnect (for carrier)	50	71,500				
2.5	1 pole - 1x2	NSYTRR23TB	Disconnect (for carrier)	50	85,800				
2.5	2 pole - 1x1	NSYTRR24SCD	Disconnect (blade)	50	469,700				

Spring terminal block- miniature passthrough. Đầu nối dạng lò xo loại nhỏ

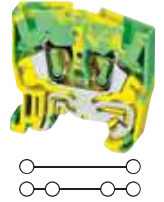

Nominal c.s.cmm ²	Type of connection	Reference Grey color	Type of block	Lot size	Unit Price	Reference Green/Yellow	Type of block	Lot size	Unit Price
2.5	1 pole - 1x1	NSYTRR22M	Passthrough	50	30,800	NSYTRR22MPE	PE	50	93,500
2.5	1 pole - 2x2	NSYTRR24M	Passthrough	50	45,100				

Terminal blocks

The new NSYTRP push-in terminal blocks use the most cost effective connection technique on the market. They reduce wiring time and eliminates the need of regular re-tightening
The insertion force of the NSYTRP push-in terminal blocks is up to 50% lower.

Meet requirement of IEC/EN 60947-7-1

Max Voltage 800V

Max Rated current: from 30A to 38A

Certifications: UL, CSA, VDE, ATEX, IECEx, GL, LR, DNV, GOST

Push-in terminal blocks

Đầu nối NSYTRP dạng push-in sử dụng công nghệ đầu nối với giá cạnh tranh nhất hiện nay. Chúng làm giảm thời gian đầu nối và hạn chế siết dây thường xuyên

Đầu nối NSYTRP push-in giảm lực siết lên đến 50% so với các đầu nối khác

Phù hợp với tiêu chuẩn IEC/EN 60947-7-1

Điện áp hoạt động tối đa: 800V

Dòng điện tối đa: từ 30A đến 38A

Tiêu chuẩn: UL, CSA, VDE, ATEX, IECEx, GL, LR, DNV, GOST

Unit price (incl.VAT) in VND

Push-in terminal block- passthrough. Đầu nối dạng push-in

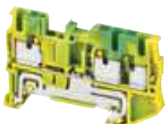

NSYTRP24D



NSYTRP24DPE



NSYTRP22SC

Normal c.s.cmm ²	Type of connection	Reference Grey color	Type of block	Lot size	Unit Price	Reference Green/Yellow	Type of block	Lot size	Unit Price
2,5	1 pole - 1x1	NSYTRP22	Passthrough	50	30,800	NSYTRP22PE	PE	50	75,900
2,5	1 pole - 1x2	NSYTRP23	Passthrough	50	36,300	NSYTRP23PE	PE	50	154,000
2,5	1 pole - 2x2	NSYTRP24	Passthrough	50	44,000	NSYTRP24PE	PE	50	192,500
4	1 pole - 1x1	NSYTRP42	Passthrough	50	41,800	NSYTRP42PE	PE	50	134,200
4	1 pole - 1x2	NSYTRP43	Passthrough	50	60,500	NSYTRP43PE	PE	50	177,100
4	1 pole - 2x2	NSYTRP44	Passthrough	50	79,200	NSYTRP44PE	PE	50	223,300

Push-in terminal block- double deck passthrough. Đầu nối dạng push-in

Normal c.s.cmm ²	Type of connection	Reference Grey color	Type of block	Lot size	Unit Price	Reference Green/Yellow	Type of block	Lot size	Unit Price
2,5	"2 pole - 1x1 1 pole - 2x2 (PE)	NSYTRP24D	Passthrough double deck	50	106,700	NSYTRP24DPE	PE double deck	50	281,600

Push-in terminal block- Disconnect. Đầu nối dạng push-in





Normal c.s.cmm ²	Type of connection	Reference Grey color	Type of block	Lot size	Unit Price
2,5	1 pole - 1x1	NSYTRP22SC	Disconnect (blade)	50	128,700
2,5	1 pole - 1x2	NSYTRP23SC	Disconnect (blade)	50	144,100
2,5	1 pole - 1x1	NSYTRP24SC	Disconnect (blade)	50	163,900
2,5	1 pole - 1x2	NSYTRP22TB	Disconnect (for carrier)	50	81,400
4	2 pole - 1x1	NSYTRP42TB	Disconnect (for carrier)	50	91,300

Terminal blocks accessories

Phụ kiện đầu nối

Unit price (incl.VAT) in VND

Accessories- Phụ kiện

			Screw terminal			Spring terminal			Plug-in terminal			
			Reference	Lot size	Unit Price	Reference	Lot size	Unit Price	Reference	Lot size	Unit Price	
	End stop for 35mm DIN rail,		NSYTRAAB35	50	20,900	NSYTRAAB35	50	20,900	NSYTRAAB35	50	20,900	
	Specific for dip- on,5,2mm miniature type		NSYTRAAB15	50	22,000	NSYTRAAB15	50	22,000				
	End plate	Grey 2pts	NSYTRAC22	50	9,900	NSYTRACR22	50	13,200	NSYTRACR22	50	13,200	
		3pts	NSYTRAC23	50	17,600	NSYTRACR23	50	13,200	NSYTRACR23	50	13,200	
		4pts	NSYTRAC24	50	18,700	NSYTRACR24	50	13,200	NSYTRACR24	50	13,200	
		3 level	NSYTRACE26	50	29,700	NSYTRACR42	50	13,200	NSYTRACR42	50	13,200	
		2 level	NSYTRACT22	50	41,800	NSYTRACR43	50	16,500	NSYTRACR43	50	16,500	
		4 pts										
	End plate	3 level	NSYTRACE24	50	20,900	NSYTRACR44	50	16,500	NSYTRACR44	50	16,500	
			NSYTRACM22	50	14,300	NSYTRACR62	50	13,200	NSYTRACRE24	50	17,600	
			NSYTRAC162	50	17,600	NSYTRACR63	50	17,600				
						NSYTRACR102	50	14,300				
	Screw bridge	2 pole	NSYTRAL702	10	223,300							
			NSYTRAL952	10	324,500							
			NSYTRAL1502	10	358,600							
	Test plug	Metalic part	NSYTRAATM1	10	86,900	NSYTRAATM1	10	86,900	NSYTRAATM1	10	86,900	
		Red Insulating sleeve	NSYTRAATP1	10	15,400	NSYTRAATP1	10	15,400	NSYTRAATP1	10	15,400	
	Screw bridge	Grey	NSYTRAFT	10	74,800	NSYTRAFT	10	74,800	NSYTRAFT	10	74,800	
		Marker tag holder	For ●AB35 end stop	NSYTRASB4	100	14,300	NSYTRASB4	10	14,300	NSYTRASB4	10	14,300
		Warning label	Yellow	NSYTRACS2	10	26,400	NSYTRACSR2	10	9,900			
				NSYTRACS4	10	35,200	NSYTRACSR4	10	12,100			
	NSYTRACS6		10	42,900	NSYTRACSR6	10	12,100					
		NSYTRACS10	10	50,600								

Plug-in bridge

			Reference	Lot size	Unit Price	Reference	Lot size	Unit Price
	Test adapter	Red 2 pole	NSYTRAL22	50	9,900	NSYTRAL42	50	9,900
		3 pole	NSYTRAL23	50	20,900	NSYTRAL43	50	30,800
		4 pole	NSYTRAL24	50	33,000	NSYTRAL44	50	45,100
		5 pole	NSYTRAL25	50	42,900	NSYTRAL45	50	53,900
		10 pole	NSYTRAL210	10	90,200	NSYTRAL410	50	92,400
		20 pole	NSYTRAL220	10	176,000	NSYTRAL420	50	176,000
	Blue 10 pole	NSYTRAL210BL	10	114,400	NSYTRAL410BL	50	114,400	
	Grey 10 pole	NSYTRAL210GR	10	114,400	NSYTRAL410GR	10	114,400	



Test plug



Warning label



Marker tag holder





Plug-in bridge

Terminal blocks accessories

Phụ kiện đầu nối

Unit price (incl.VAT) in VND

Accessories- Phụ kiện										
Printed character	For 2.5mm ² : NSY TRV/ TRR/TRP/TRH			For 4mm ² : NSY TRV/ TRR/TRP/TRH			For 6mm ² : NSY TRV/ TRR/TRP/TRH			
	Terminal blocks width: 5.2mm			Terminal blocks width: 6.2mm			Terminal blocks width: 8.2mm			
	Reference	Lot size	Unit Price	Reference	Lot size	Unit Price	Reference	Lot size	Unit Price	
 Clip-in marking strips	1...10	NSYTRAB510	10	23,100	NSYTRAB610	50	23,100	NSYTRAB810	50	29,700
	11...20	NSYTRAB520	10	23,100	NSYTRAB620	50	23,100	NSYTRAB820	50	29,700
	21...30	NSYTRAB530	10	23,100	NSYTRAB630	50	23,100	NSYTRAB830	50	29,700
	31...40	NSYTRAB540	10	23,100	NSYTRAB640	50	23,100	NSYTRAB840	50	29,700
	41...50	NSYTRAB550	10	23,100	NSYTRAB650	50	23,100	NSYTRAB850	50	29,700
	51...60	NSYTRAB560	10	23,100	NSYTRAB660	50	23,100	NSYTRAB860	50	29,700
	61...70	NSYTRAB570	10	23,100	NSYTRAB670	50	23,100	NSYTRAB870	50	29,700
	71...80	NSYTRAB580	10	23,100	NSYTRAB680	50	23,100	NSYTRAB880	50	29,700
	81...90	NSYTRAB590	10	23,100	NSYTRAB690	50	23,100	NSYTRAB890	50	29,700
	91...100	NSYTRAB5100	10	23,100	NSYTRAB6100	50	23,100	NSYTRAB8100	50	29,700
1...100 (1-10,11-20,...91-100)	NSYTRAB51100	10	228,800	NSYTRAB61100	50	228,800				
L1, L2, L3, N, PE	NSYTRAB5L1N	10	23,100	NSYTRAB6L1N	50	23,100				
 Marking accessories	For >10mm ² : NSY TRV/TRR/ TRP/TRH			For 2.5mm ² : NSY TRV/ TRR/TRP/TRH			For 4mm ² : NSY TRV/ TRR/TRP/TRH			
	Terminal blocks width: ≥10.2mm			Terminal blocks width: 5.2mm			Terminal blocks width: 6.2mm			
	1...10	NSYTRAB1010	10	33,000	NSYTRABF510	50	23,100	NSYTRABF610	50	23,100
	11...20	NSYTRAB1020	10	33,000	NSYTRABF520	50	23,100	NSYTRABF620	50	23,100
	21...30	NSYTRAB1030	10	33,000	NSYTRABF530	50	23,100	NSYTRABF630	50	23,100
	31...40	NSYTRAB1040	10	33,000	NSYTRABF540	50	23,100	NSYTRABF640	50	23,100
	41...50	NSYTRAB1050	10	33,000	NSYTRABF550	50	23,100	NSYTRABF650	50	23,100
	51...60	NSYTRAB1060	10	33,000						
	61...70	NSYTRAB1070	10	33,000						
	71...80	NSYTRAB1080	10	33,000						
81...90	NSYTRAB1090	10	33,000							
91...100	NSYTRAB10100	10	33,000							
Conductor diameter	Marking collars for cables									
2 to 3.5mm	NSYTRABCV23	500	4,400							
3 to 5mm	NSYTRABCV35	500	6,600							
5 to 8mm	NSYTRABCV58	500	7,700							
Color	Marking insert for collars									
White	NSYTRACP1	10	178,200							
Yellow	NSYTRACP2	10	202,400							
	Marking card for collars									
	NSYTRABCP5	10	190,300							

